

REVISION HISTORY			
REV	DESCRIPTION	DATE	APPROVED
A	RELEASE FOR APPROVAL	9/18/2014	C.R.
B	REVISED PER CUSTOMER REQUEST	12/23/2014	C.R.

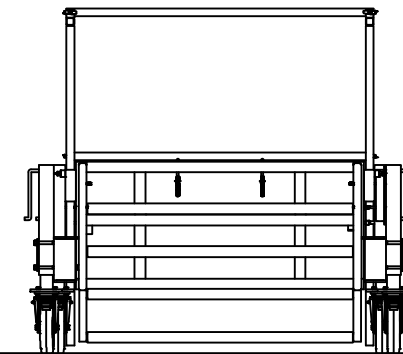

NOTES:  
TWO ALUMINUM STYLE PLATFORMS 500 LBS  
CAPACITY EACH

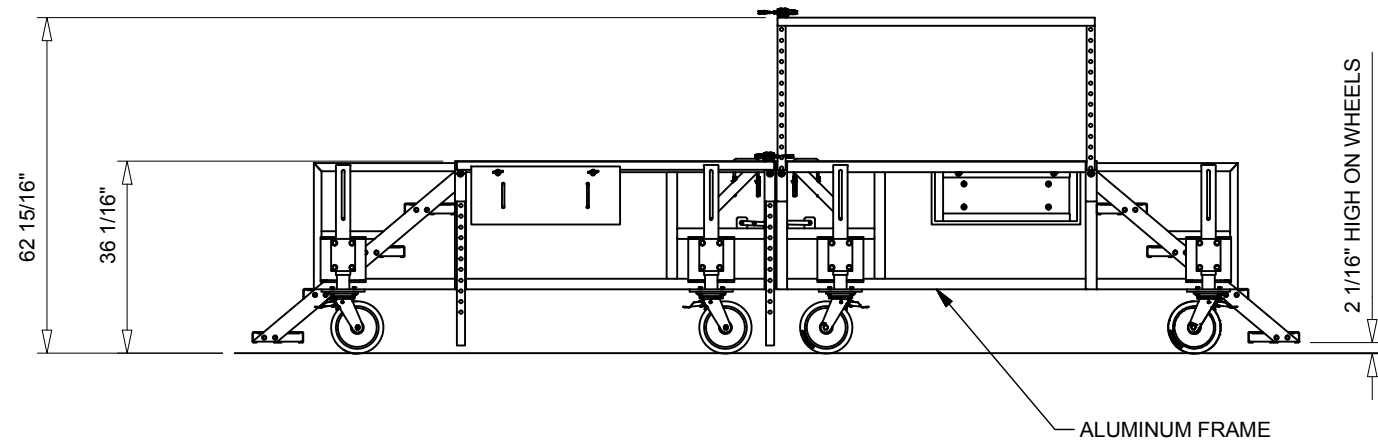
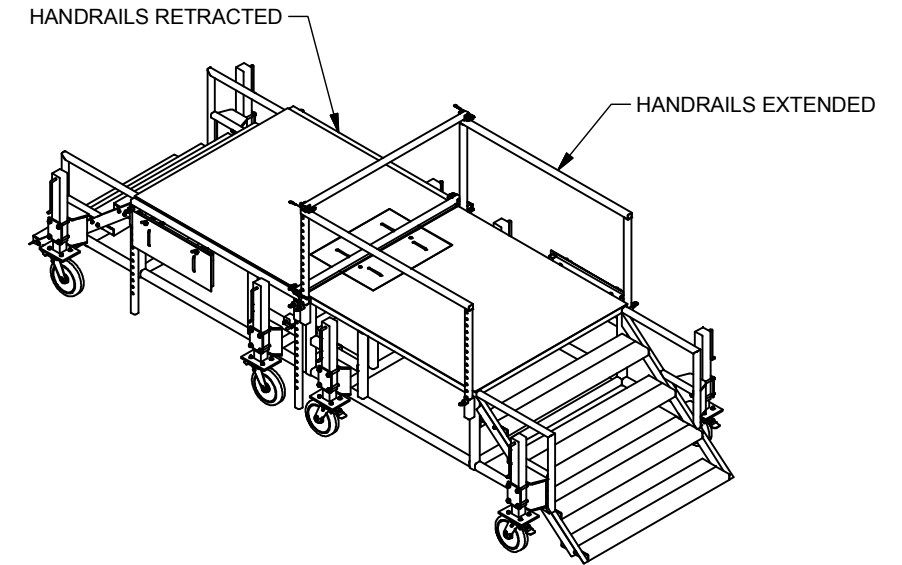
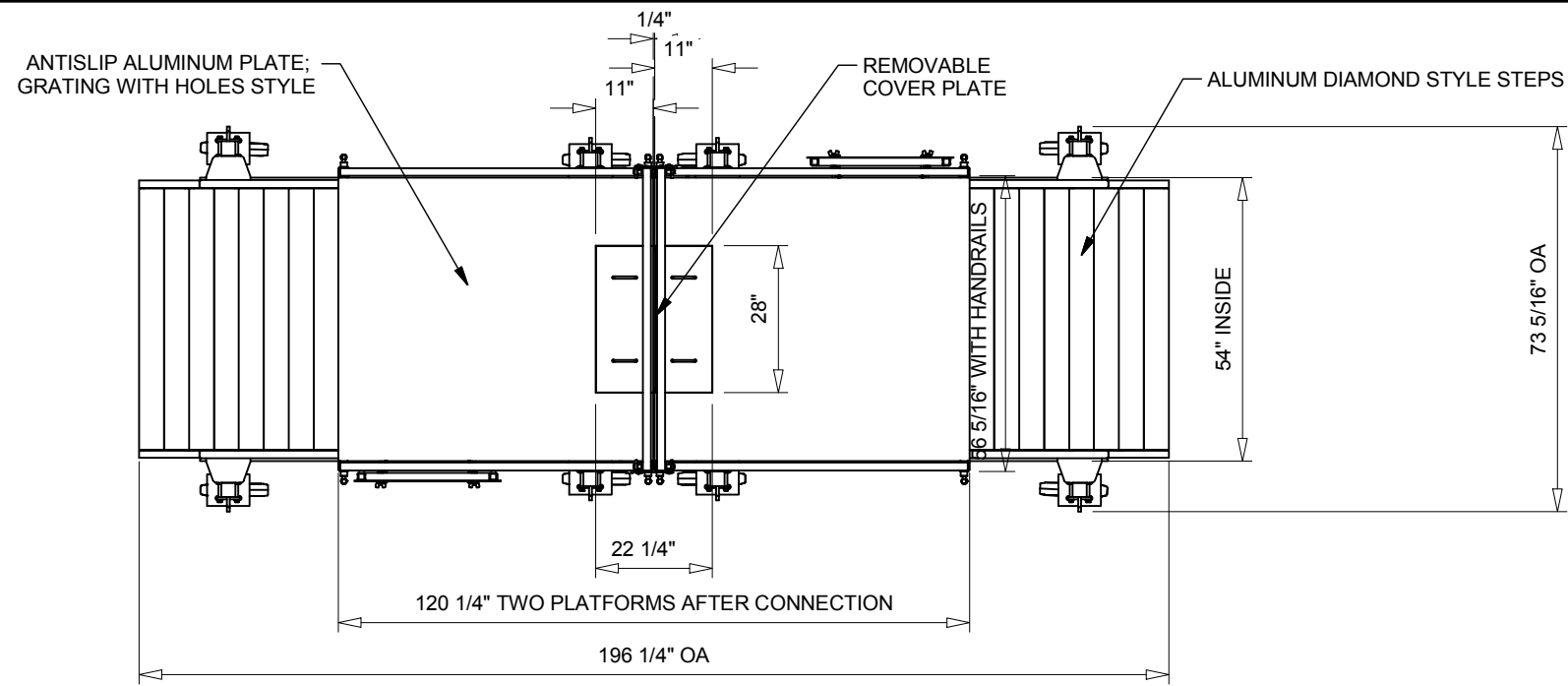
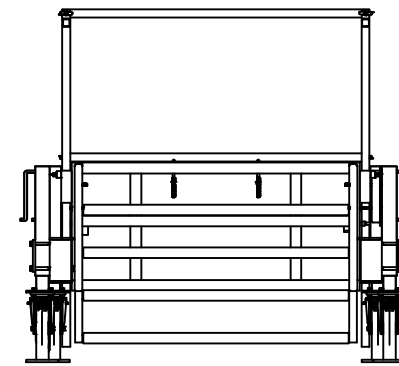
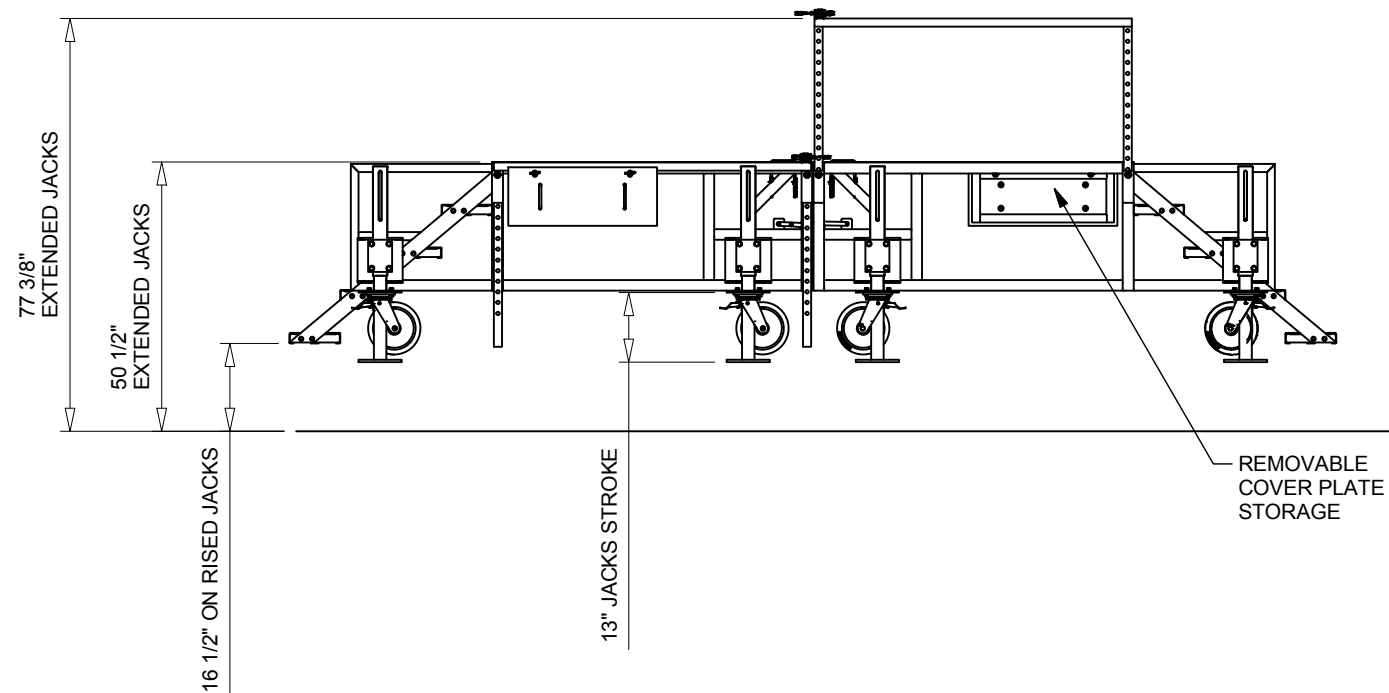

APPROVAL	
THIS DRAWING IS SUBMITTED FOR APPROVAL ONLY. THIS DRAWING IS NOT TO BE USED FOR CONSTRUCTION UNTIL APPROVED.	
CUSTOMER IS RESPONSIBLE FOR CONFIRMING THE DIMENSIONS AND GENERAL LAYOUT, NOTING ANY EXISTING CONDITIONS THAT MAY AFFECT THIS LAYOUT.	
<input type="checkbox"/> APPROVED AS DRAWN	<input type="checkbox"/> APPROVED AS NOTED
<input type="checkbox"/> REVISE AND RESUBMIT	
BY:	DATE:
TITLE:	
COMPANY:	

THIS DRAWING AND THE INTELLECTUAL INFORMATION ON THIS DRAWING ARE THE PROPERTY OF LIFTSAFE ENGINEERING & SERVICE GROUP INC. AND MAY NOT BE REPRODUCED OR USED IN ANY MANNER WITHOUT OUR WRITTEN CONSENT

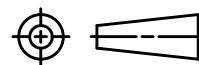

THIRD ANGLE PROJECTION

Tolerance Unless Noted Otherwise				
ANGLE	FRACTION	DECIMAL PLACES	INCHES	MILLIMETRES
± 1/2°	± 1/16	.XXX	± .005	± 0.1
		.XX	± .010	± 0.3
		.X	± .020	± 0.5

Model No. :		 <b>LIFTSAFE ENGINEERING &amp; SERVICE GROUP INC.</b> www.liftsafeinspections.com T. (519) 896-2430/1-800-977-2005, Email: info@liftsafeinspections.com F. (519) 896-2085		
Work Oder No.	-			
Ref. Drawing:				
Part No.	-	Customer & Location: <b>LIFTSAFE FALL PROTECTION AYR, ONTARIO</b>		
Checked By:	R.B.	Date: SEP. 18.2014	Description:	Project: <b>B737 MAIN LANDING GEAR STAND CAP. 500 LBS</b>
Designed By:	G.R.	Date: SEP. 11.2014	SIZE	SCALE: N.T.S.
Drawn By:	G.R.	Date: SEP. 18.2014	B	SHEET 1 OF 1
			DWG NO:	14-3355-ASSY-GA
			REV	B