

# Panasonic

Hybrid IP-PBX

User Manual

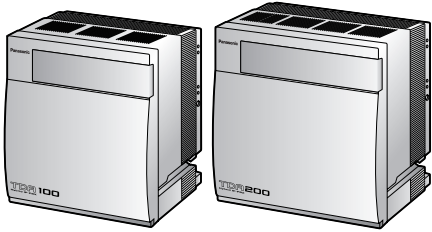

KX-TDA100  
Model KX-TDA200



Thank you for purchasing a Panasonic Hybrid IP-PBX.  
Please read this manual carefully before using this product and save this manual for future use.

**KX-TDA100/KX-TDA200: Version 2.0**

## Feature Highlights

### Call Center

This PBX can establish Incoming Call Distribution Groups (ICD Group) by which a large volume of calls from the external customers could be received. One extension can act as the supervisor, and monitor other group members.

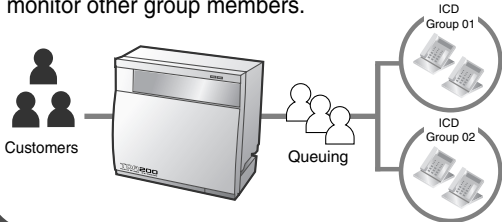

1.8 Call Center (Page 87)

### Voice Mail Integration

You can forward your calls to a voice processing system and let calling parties leave messages in your mailbox when you are unable to receive calls.

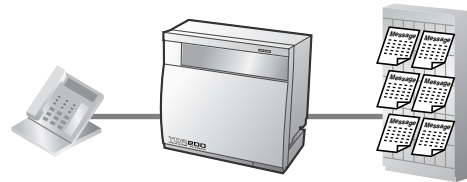

1.9.5 Voice Processing System (Page 96)

### Wireless System

This PBX optionally supports a Portable Station (PS) system. PSs can be used on the PBX with other wired telephones.



Appendix (Page 151)

### PC Phone/PC Console

This PBX supports the PC Phone/PC Console when your computer is connected to certain Panasonic telephones via USB interface. The PC Phone/PC Console provides advanced control and monitoring of your PBX.

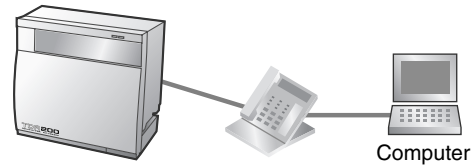

Consult your dealer

### Easy Operation

If you are using a Panasonic telephone that is equipped with a Navigator Key/Jog Dial and a display, it helps you to access the desired feature easily. Also, you will be informed of the arrival of an incoming call or a message waiting by the lamp if it is equipped.



Navigator Key

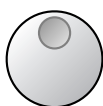

Jog Dial



Message/Ringer Lamp

1.1 Before Operating the Telephones (Page 14)

### Call Record

#### (Station Message Detail Recording)

This PBX can record or print out call information: date, time, extension no., dialed no., duration, etc.

Date	Time	Ext	.....
01/02/02	10:03AM	1230	.....
01/02/02	11:07AM	2230	.....

Consult your dealer

---

### In This Manual,

- Proprietary Telephone is abbreviated as "PT".  
Single Line Telephone is abbreviated as "SLT".  
Portable Station is abbreviated as "PS".  
Proprietary Telephone with a Display is abbreviated as "Display PT".  
Digital Proprietary Telephone is abbreviated as "DPT".
- The following icons are used frequently.



Hints



Conditions

---

# ***Important Information***

## **WARNING**

- **THIS UNIT MAY ONLY BE INSTALLED AND SERVICED BY QUALIFIED SERVICE PERSONNEL.**
- **WHEN A FAILURE OCCURS WHICH EXPOSES ANY INTERNAL PARTS, DISCONNECT THE POWER SUPPLY CORD IMMEDIATELY AND RETURN THIS UNIT TO YOUR DEALER.**
- **DISCONNECT THE TELECOM CONNECTION BEFORE DISCONNECTING THE POWER CONNECTION PRIOR TO RELOCATING THE EQUIPMENT, AND RECONNECT THE POWER FIRST.**
- **THIS UNIT IS EQUIPPED WITH A GROUNDING CONTACT PLUG. FOR SAFETY REASONS, THIS PLUG MUST ONLY BE CONNECTED TO A GROUNDING CONTACT SOCKET WHICH HAS BEEN INSTALLED ACCORDING TO REGULATIONS.**
- **THE POWER SUPPLY CORD IS USED AS THE MAIN DISCONNECT DEVICE. ENSURE THAT THE SOCKET-OUTLET IS LOCATED/INSTALLED NEAR THE EQUIPMENT AND IS EASILY ACCESSIBLE.**
- **TO PREVENT THE RISK OF FIRE OR ELECTRIC SHOCK, DO NOT EXPOSE THIS PRODUCT TO RAIN OR MOISTURE.**
- **TO PROTECT THIS UNIT FROM STATIC ELECTRICITY, DO NOT TOUCH ANY CONNECTORS OF THE UNIT.**

---

# IMPORTANT SAFETY INSTRUCTIONS

When using your telephone equipment, basic safety precautions should always be followed to reduce the risk of fire, electric shock and injury to persons, including the following:

1. Read and understand all instructions.
2. Follow all warnings and instructions marked on the product.
3. Unplug this product from the wall outlet before cleaning. Do not use liquid cleaners or aerosol cleaners. Use a damp cloth for cleaning.
4. Do not use this product near water, for example, near a bathtub, wash bowl, kitchen sink, or laundry tub, in a wet basement, or near a swimming pool.
5. Do not place this product on an unstable cart, stand, or table. The product may fall, causing serious damage to the product.
6. Slots and openings in the cabinet and the back or bottom are provided for ventilation; to protect it from overheating, these openings must not be blocked or covered. The openings should never be blocked by placing the product on a bed, sofa, rug, or other similar surface. This product should never be placed near or over a radiator or other heat source. This product should not be placed in a built-in installation unless proper ventilation is provided.
7. This product should be operated only from the type of power source indicated on the product label. If you are not sure of the type of power supply to your home, consult your dealer or local power company.
8. This product is equipped with a 3-wire grounding type plug, a plug having a third (grounding) pin. This plug will only fit into a grounding type power outlet. This is a safety feature. If you are unable to insert the plug into the outlet, contact your electrician to replace your obsolete outlet. Do not defeat the safety purpose of the grounding type plug.
9. Do not allow anything to rest on the power cord. Do not locate this product where the cord will be abused by people walking on it.
10. Do not overload wall outlets and extension cords as this can result in the risk of fire or electric shock.
11. Never push objects of any kind into this product through cabinet slots as they may touch dangerous voltage points or short out parts that could result in a risk of fire or electric shock. Never spill liquid of any kind on the product.
12. To reduce the risk of electric shock, do not disassemble this product, but take it to a qualified person when some service or repair work is required. Opening or removing covers may expose you to dangerous voltages or other risks. Incorrect reassembly can cause electric shock when the appliance is subsequently used.
13. Unplug this product from the wall outlet and refer servicing to qualified service personnel under the following conditions:
  - a) When the power supply cord or plug is damaged or frayed.
  - b) If liquid has been spilled into the product.
  - c) If the product has been exposed to rain or water.
  - d) If the product does not operate normally by following the operating instructions. Adjust only those controls that are covered by the operating instructions because improper adjustment of other controls may result in damage and will often require extensive work by a qualified technician to restore the product to normal operation.
  - e) If the product has been dropped or the cabinet has been damaged.
  - f) If the product exhibits a distinct change in performance.

- 
14. Avoid using a telephone (other than a cordless type) during an electrical storm. There may be a remote risk of electric shock from lightning.
  15. Do not use the telephone to report a gas leak in the vicinity of the leak.

## **SAVE THESE INSTRUCTIONS**

---

# Attention

- If there is any trouble, disconnect the unit from the telephone line. Plug the telephone directly into the telephone line. If the telephone operates properly, do not reconnect the unit to the line until the problem has been repaired by an authorized Panasonic Factory Servicenter. If the telephone does not operate properly, chances are that the problem is in the telephone system, and not in the unit.
- Keep the unit away from heating appliances and electrical noise generating devices such as fluorescent lamps, motors and televisions. These noise sources can interfere with the performance of the unit.
- This unit should be kept free of dust, moisture, high temperature (more than 40 °C [104 °F]) and vibration, and should not be exposed to direct sunlight.
- Never attempt to insert wires, pins, etc., into the vents or holes of this unit.
- Do not use benzene, thinner, or the like, or any abrasive powder to clean the cabinet. Wipe it with a soft cloth.
- Do not use any handset other than a Panasonic handset for KX-TDA100/KX-TDA200 use.

## When you ship the product

Carefully pack and send it prepaid, adequately insured and preferably in the original carton. Attach a postage-paid letter, detailing the symptom, to the outside of the carton. DO NOT send the product to the Executive or Regional Sales offices. They are NOT equipped to make repairs.

## Product service

Panasonic Factory Servicenters for this product are listed in the servicenter directory. Consult your certified Panasonic dealer for detailed instructions.

The serial number of this product may be found on the label affixed to the side of the unit. You should note the model number and the serial number of this unit in the space provided and retain this manual as a permanent record of your purchase to aid in identification in the event of theft.

MODEL NO.:

SERIAL NO.:

## For your future reference

DATE OF PURCHASE

NAME OF DEALER

DEALER'S ADDRESS

DEALER'S TELEPHONE NO.

---

# **F.C.C. REQUIREMENTS AND RELEVANT INFORMATION**

## **1. Notification to the Telephone Company**

This equipment complies with Part 68 of the FCC rules and the requirements adopted by the ACTA. On the side of this equipment is a label that contains, among other information, a product identifier in the format US: ACJMF03AKX-TDA100. If requested, this number must be provided to the telephone company.

Installation must be performed by a qualified professional installer. If required, provide the telephone company with the following technical information:

- Telephone numbers to which the system will be connected
- Make: Panasonic
- Model: KX-TDA100 and KX-TDA200
- Certification No.: found on the side of the unit
- Ringer Equivalence No.: 0.3A
- Facility Interface Code: 02LS2, 04DU9.BN/DN/1KN/1SN, METALLIC
- Service Order Code: 9.0F, 6.0P
- Required Network Interface Jack: RJ21X, RJ48C, RJ2HX

## **2. Ringer Equivalence Number (REN)**

The REN is used to determine the number of devices that may be connected to a telephone line. Excessive RENs on a telephone line may result in the devices not ringing in response to an incoming call. In most, but not all areas, the sum of RENs should not exceed five (5.0). To be certain of the number of devices that may be connected to a line, as determined by the total RENs, contact the local telephone company. The REN for this product is part of the product identifier that has the format US: ACJMF03AKX-TDA100. The digits represented by 03 are the REN without a decimal point (e.g., 03 is a REN of 0.3). For earlier products, the REN is separately shown on the label.

## **3. Incidence of Harm to the Telephone Lines**

If this equipment causes harm to the telephone network, the telephone company will notify you in advance that temporary discontinuance of service may be required. But if advance notice isn't practical, the telephone company will notify the customer as soon as possible. Also, you will be advised of your right to file a complaint with the FCC if you believe it is necessary.

## **4. Changes in Telephone Company Communications Facilities, Equipment, Operations and Procedures**

The telephone company may make changes in its facilities, equipment, operations or procedures that could affect the operation of the equipment. If this happens the telephone company will provide advance notice in order for you to make necessary modifications to maintain uninterrupted service.

## **5. Trouble with this equipment**

If trouble is experienced with this equipment, for repair or warranty information, please see the attached warranty, which includes the Servicenter Directory. If the equipment is causing harm to the telephone network, the telephone company may request that you disconnect the equipment until the problem is resolved.

## **6. Connection to Party Line**

Connection to party line service is subject to state tariffs. Contact the state public utility commission, public service commission or corporation commission for information.



---

## 7. Combined Use with Alarm Equipment

If your home has specially wired alarm equipment connected to the telephone line, ensure the installation of this equipment does not disable your alarm equipment. If you have questions about what will disable alarm equipment, consult your telephone company or a qualified installer.

### **Note**

This equipment has been tested and found to comply with the limits for a Class B digital device, pursuant to Part 15 of the FCC Rules. These limits are designed to provide reasonable protection against harmful interference in a residential installation. This equipment generates, uses, and can radiate radio frequency energy and, if not installed and used in accordance with the instructions, may cause harmful interference to radio communications. However, there is no guarantee that interference will not occur in a particular installation. If this equipment does cause harmful interference to radio or television reception, which can be determined by turning the equipment off and on, the user is encouraged to try to correct the interference by one or more of the following measures:

- Reorient or relocate the receiving antenna.
- Increase the separation between the equipment and receiver.
- Connect the equipment into an outlet on a circuit different from that to which the receiver is connected.
- Consult the dealer or an experienced radio/TV technician for help.

### **CAUTION**

Any changes or modifications not expressly approved by the party responsible for compliance could void the user's authority to operate this device.

When programming emergency numbers and/or making test calls to emergency numbers:

1. Remain on the line and briefly explain to the dispatcher the reason for the call before hanging up.
2. Perform such activities in the off-peak hours, such as early morning hours or late evenings.

### **WARNING**

**The software contained in the ARS and TRS features to allow user access to the network must be upgraded to recognize newly established network area codes and exchange codes as they are placed into service.**

**Failure to upgrade the premises PBXs or peripheral equipment to recognize the new codes as they are established will restrict the customer and the customer's employees from gaining access to the network and to these codes.**

**KEEP THE SOFTWARE UP-TO-DATE WITH THE LATEST DATA.**

---

## For Cell Station

### **CAUTION**

Any changes or modifications not expressly approved by the party responsible for compliance could void user's authority to operate this device.

### **Note**

This equipment has been tested and found to comply with the limits for a Class B digital device, pursuant to Part 15 of the FCC Rules. These limits are designed to provide reasonable protection against harmful interference in a residential installation. This equipment generates, uses, and can radiate radio frequency energy and, if not installed and used in accordance with the instructions, may cause harmful interference to radio communications. However, there is no guarantee that interference will not occur in a particular installation. If this equipment does cause harmful interference to radio or television reception, which can be determined by turning the equipment off and on, the user is encouraged to try to correct the interference by one or more of the following measures:

- Reorient or relocate the receiving antenna.
- Increase the separation between the equipment and receiver.
- Connect the equipment into an outlet on a circuit different from that to which the receiver is connected.
- Consult the dealer or an experienced radio/TV technician for help.

Some wireless telephones operate at frequencies that may cause interference to nearby TVs and VCRs. To minimize or prevent such interference, the base of the wireless telephone should not be placed near or on top of a TV or VCR. If interference is experienced, move the wireless telephone further away from the TV or VCR. This will often reduce, or eliminate, interference.

Operating near 2.4 GHz electrical appliances may cause interference. Move away from the electrical appliances.

### **CAUTION**

To comply with FCC RF exposure requirements in uncontrolled environment:

- This equipment must be installed and operated in accordance with provided instructions and a minimum 20 cm (8 in) spacing must be provided between antenna and all person's body (excluding extremities of hands, wrist and feet) during wireless modes of operation.
- This transmitter must not be co-located or operated in conjunction with any other antenna or transmitter.

**Medical**—consult the manufacturer of any personal medical devices, such as pacemakers, to determine if they are adequately shielded from external RF (radio frequency) energy. (The unit operates in the frequency range of 2401 MHz to 2480 MHz, and the power output level can range from 0.004 W to 0.4 W.) Do not use the unit in health care facilities if any regulations posted in the area instruct you not to do so. Hospitals or health care facilities may be using equipment that could be sensitive to external RF (radio frequency) energy.

---

# Table of Contents

<b>1</b>	<b>Operation.....</b>	<b>13</b>
1.1	<b>Before Operating the Telephones .....</b>	<b>14</b>
1.1.1	Before Operating the Telephones .....	14
1.2	<b>Making Calls.....</b>	<b>23</b>
1.2.1	Basic Calling.....	23
1.2.2	Easy Dialing.....	27
1.2.3	Redial.....	31
1.2.4	When the Dialed Line is Busy or There is No Answer .....	31
1.2.5	Alternate Calling—Ring/Voice.....	38
1.2.6	Calling without Restrictions.....	39
1.2.7	Direct Inward System Access (DISA) .....	40
1.2.8	Remote Setting .....	42
1.3	<b>Receiving Calls .....</b>	<b>44</b>
1.3.1	Answering Calls .....	44
1.3.2	Hands-free Answerback.....	45
1.3.3	Call Pickup .....	45
1.3.4	Trunk Answer From Any Station (TAFAS) .....	46
1.3.5	ANSWER/RELEASE Button .....	47
1.4	<b>During a Conversation.....</b>	<b>49</b>
1.4.1	Call Transfer.....	49
1.4.2	Call Hold .....	51
1.4.3	Call Splitting.....	55
1.4.4	Call Waiting.....	56
1.4.5	Multiple Party Conversation .....	60
1.4.6	Mute.....	67
1.4.7	Off-hook Monitor .....	67
1.4.8	Headset Operation.....	68
1.5	<b>Absence Settings.....</b>	<b>70</b>
1.5.1	Call Forwarding.....	70
1.5.2	Absent Message .....	73
1.5.3	Extension Lock.....	75
1.6	<b>Paging .....</b>	<b>76</b>
1.6.1	Paging.....	76
1.6.2	Answering/Denying a Paging Announcement.....	77
1.7	<b>Extension Settings .....</b>	<b>78</b>
1.7.1	Timed Reminder .....	78
1.7.2	Do Not Disturb (DND) .....	79
1.7.3	Call Waiting/Off-hook Call Announcement (OHCA)/Whisper OHCA .....	81
1.7.4	Calling Line Identification Presentation (CLIP) .....	82
1.7.5	Calling Line Identification Restriction (CLIR) .....	82
1.7.6	Executive Busy Override Deny .....	83
1.7.7	Background Music (BGM).....	83
1.7.8	Data Line Security .....	84
1.7.9	Time Service.....	84
1.7.10	Paralleled Telephone.....	85
1.7.11	Wireless XDP Parallel Mode.....	85
1.7.12	Extension Feature Clear .....	86

<b>1.8</b>	<b>Call Center</b> .....	<b>87</b>
1.8.1	Log-in/Log-out, Wrap-up .....	87
1.8.2	Incoming Call Distribution Group Monitor .....	89
1.8.3	Manual Queue Redirection .....	92
<b>1.9</b>	<b>User-supplied Equipment</b> .....	<b>93</b>
1.9.1	Doorphone/Door Opener .....	93
1.9.2	External Relay.....	94
1.9.3	External Sensor .....	95
1.9.4	Host PBX .....	95
1.9.5	Voice Processing System.....	96
<b>1.10</b>	<b>Walking Extension</b> .....	<b>102</b>
1.10.1	Walking Extension.....	102
<b>1.11</b>	<b>Display Proprietary Telephone</b> .....	<b>103</b>
1.11.1	Call Log.....	103
1.11.2	Directories.....	107
1.11.3	System Feature Access .....	111
<b>2</b>	<b>Manager Operation</b> .....	<b>113</b>
<b>2.1</b>	<b>Control Features</b> .....	<b>114</b>
2.1.1	Extension Control.....	114
2.1.2	Time Service Mode Control .....	114
2.1.3	Dial Tone Transfer .....	116
2.1.4	External Background Music (BGM).....	116
2.1.5	Outgoing Messages (OGM) .....	117
2.1.6	Hospitality Features .....	118
2.1.7	Network Direct Station Selection (NDSS) Monitor Release .....	123
<b>3</b>	<b>Customizing Your Phone &amp; System</b> .....	<b>125</b>
<b>3.1</b>	<b>Personal Programming</b> .....	<b>126</b>
3.1.1	Personal Programming.....	126
3.1.2	Settings on the Programming Mode.....	127
3.1.3	Customizing the Buttons .....	137
<b>3.2</b>	<b>Manager Programming</b> .....	<b>141</b>
3.2.1	Programming Information.....	141
3.2.2	Manager Programming .....	142
<b>3.3</b>	<b>System Programming</b> .....	<b>143</b>
3.3.1	Programming Information.....	143
3.3.2	System Programming.....	146
<b>4</b>	<b>Appendix</b> .....	<b>151</b>
<b>4.1</b>	<b>Troubleshooting</b> .....	<b>152</b>
4.1.1	Troubleshooting.....	152
<b>4.2</b>	<b>Feature Number Table</b> .....	<b>155</b>
4.2.1	Feature Number Table.....	155
<b>4.3</b>	<b>Tone</b> .....	<b>163</b>
4.3.1	Tone .....	163
<b>4.4</b>	<b>Revision History</b> .....	<b>167</b>
4.4.1	Version 1.1 .....	167
4.4.2	Version 2.0 .....	167
	<b>Index</b> .....	<b>169</b>

---

# **Section 1**

## **Operation**

*This chapter shows you step by step how to use each feature.  
Read this chapter to become familiar with the many useful  
features of this PBX.*

# 1.1 Before Operating the Telephones

## 1.1.1 Before Operating the Telephones

### ◆◆ What Kind of Telephone Can Be Used?

You can use a single line telephone (SLT), such as a rotary pulse telephone or a Panasonic proprietary telephone (PT) such as the KX-T7636 or KX-NT136. You can also use a Panasonic Portable Station (PS), e.g., KX-TD7690. Use the feature depending on the telephone you are using. If you are using a Panasonic

proprietary telephone with a special feature button such as  or a display (Display PT) or both, you can follow the operation with the button or display messages for easy programming.

If you use a large display telephone (e.g., KX-T7636), you can follow the displayed messages to use the features. If your telephone does not have feature buttons and/or a display, you may operate the PBX by entering a feature number instead. Follow the operation for your type of telephone.

If you use a Console, you can use the buttons on the Console as the buttons on the connected proprietary telephone.



- If you use a Panasonic proprietary telephone which does not have feature buttons, you may change one of the unused flexible buttons to a feature button. Refer to "3.1.3 Customizing the Buttons".

### Portable Station (PS) Registration

You must register your PS in the PBX and determine its extension number before initial use. For PS registration, consult your dealer.

### ◆◆ Feature Numbers

To use certain features, you need to enter specified feature numbers (and an additional parameter, if required).

There are two types of feature numbers as follows:

- Flexible feature number
- Fixed feature number

Fixed feature numbers cannot be changed. However, you can change the flexible numbers to other numbers for easier use. If you want to change the numbers, consult your dealer. In this manual, the default numbers (factory installed) are used for operations.

A flexible number is shown as  (half-shaded key). Use the new programmed number if you have changed the feature number. Write the new number in the "Feature Number Table" (Appendix).



**If you use a single line telephone which does not have the "\*" or "#" keys;**  
it is not possible to access features that have "\*" or "#" in their feature numbers.

## ◆◆ Tone

You will hear various tones, during or after an operation, for confirmation. Refer to "4.3.1 Tone" (Appendix).

## ◆◆ Display

In this manual, you will see "the display ...". This refers to the display of a Panasonic proprietary telephone. If your telephone is not a Panasonic display proprietary telephone, the message will not be displayed.

If you use a Panasonic display proprietary telephone, the display helps you confirm the settings. Some proprietary telephones also give you easy access to features. A message is displayed depending on the feature. By pressing the corresponding button on the side or at the bottom of the display, or pressing the Navigator Key, you can access the desired feature.

Furthermore, depending on the display proprietary telephone, you can operate features or make calls using the display message. Refer to "1.11 Display Proprietary Telephone".

### Your Extension Number

If you use a Panasonic display proprietary telephone, you can check your own extension number on the display. Press the TRANSFER button or Soft (S1) button while on-hook.

## ◆◆ Using a Navigator Key/Jog Dial/Volume Key

The Navigator Key can be used for the display contrast and the volume control or you can search for desired items on the display. Press the Navigator Key/Volume Key or rotate the Jog Dial in the desired direction. The contrast or the volume level and the items will change as follows:

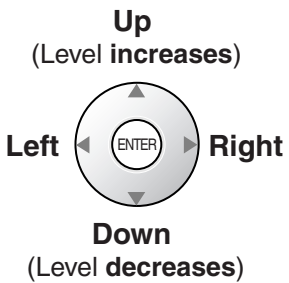
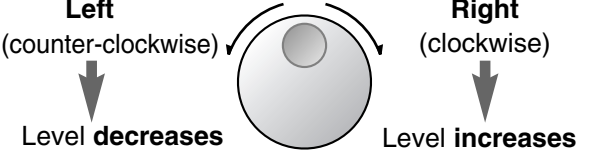
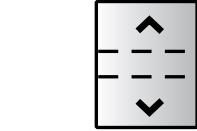
Navigator Key	Jog Dial	Volume Key
 <p>Up (Level increases)</p> <p>Left    Right</p> <p>Down (Level decreases)</p>	 <p>Left (counter-clockwise)    Right (clockwise)</p> <p>Level decreases    Level increases</p>	 <p>Up (Level increases)</p> <p>Down (Level decreases)</p>

## ◆◆ Examples











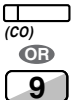



The displays and the illustrations shown as examples are from a telephone connected to the KX-TDA200.

## ◆◆ Restrictions

Some features may be restricted at your extension under the system programming. Consult your manager or dealer.

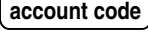
## ◆◆ Icon Descriptions

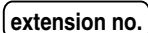
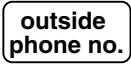
The following icons show you the feature availability, notes and action to use the features.











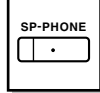

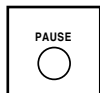

	This feature cannot be used with a single line telephone.		Seize a CO line (One of the following).
	See "Programming" for Related Programming if necessary.		<ul style="list-style-type: none"> <li>• Press the CO button.</li> <li>• Dial automatic line access number 9.</li> <li>• Dial CO line group access number and CO line group number.</li> </ul>
	Off-hook (One of the following). <ul style="list-style-type: none"> <li>• Lift the handset.</li> <li>• Press the SP-PHONE button.</li> <li>• Press the MONITOR button. (To start talking, lift the handset.)</li> <li>• Press TALK button.</li> </ul>		Press the Call button on the Doorphone.
	On-hook (One of the following). <ul style="list-style-type: none"> <li>• Hang up.</li> <li>• Press the SP-PHONE button.</li> <li>• Press the MONITOR button.</li> <li>• Press CANCEL button.</li> </ul>		Press the hookswitch lightly.
	Press the corresponding feature button on the proprietary telephone.		Talk.
	Enter the required number. <Example>  Enter the account code.		You will hear a busy, confirmation, dial, ring or ringback tone. <ul style="list-style-type: none"> <li>B. Tone: Busy Tone</li> <li>C. Tone: Confirmation Tone</li> <li>D. Tone: Dial Tone</li> <li>R. Tone: Ring Tone</li> <li>R. B. Tone: Ringback Tone</li> </ul>
	Dial an extension number.		Dial outside phone number.
	Dial the telephone number.		





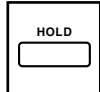

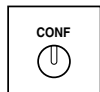

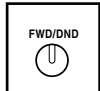







## ◆◆ When You Use a Panasonic Proprietary Telephone

If you use a Panasonic proprietary telephone and the Console, they may have some of the useful feature buttons described below. For a PS user, refer to "Operating Instructions" for PS. These buttons make operations simple. The illustrations may differ from the buttons on your telephone.

### Fixed Buttons

	<p><b>CO:</b> Used to make or receive an outside call. (Button assignment is required.) Also used as feature buttons. (Button assignment is required.) (Only the CO line "number" [e.g., 1, 2] may be shown on some telephones.)</p>		<p><b>SP-PHONE:</b> Used for hands-free operation.</p>
	<p><b>AUTO DIAL/STORE:</b> Used for System/Personal Speed Dialing or storing program changes.</p>		<p><b>PAUSE:</b> Used to insert a pause when storing a telephone number. This button also functions as the PROGRAM button when there is no PROGRAM button on your telephone.</p>
	<p><b>REDIAL:</b> Used to redial the last dialed number.</p>		<p><b>MESSAGE:</b> Used to leave a message waiting indication or call back the party who left the message waiting indication.</p>
	<p><b>INTERCOM:</b> Used to make or receive intercom calls.</p>		<p><b>Soft Buttons:</b> Used to select the item displayed on the bottom of the display.</p>
	<p><b>MONITOR:</b> Used for hands-free dialing. You can monitor the party's voice in hands-free mode.</p>		<p><b>AUTO ANS (Auto Answer)/MUTE:</b> Used to receive an incoming call in hands-free mode or mute the microphone during a conversation.</p>
	<p><b>TRANSFER:</b> Used to transfer a call to another party.</p>		<p><b>HOLD:</b> Used to place a call on hold.</p>
	<p><b>FLASH/RECALL:</b> Used to disconnect the current call and make another call without hanging up. This button can also be used as a CANCEL button while on-hook.</p>		<p><b>CONF (Conference):</b> Used to establish a multiple party conversation.</p>
	<p><b>VOICE CALL/MUTE:</b> Used to monitor an intercom call automatically, but it cannot be used for hands-free conversations. It also mutes the handset microphone during a conversation.</p>		<p><b>Call Forwarding (FWD)/Do Not Disturb (DND):</b> Used to perform Call Forwarding (FWD) or Do Not Disturb (DND).</p>

## 1.1 Before Operating the Telephones

 	<p><b>PROGRAM:</b> Used to enter and exit the Programming mode.</p>		<p><b>ANSWER:</b> Used to answer an incoming call.</p>
	<p><b>RELEASE:</b> Used to disconnect the line.</p>	   	<p><b>Navigator Key/Jog Dial/Volume Key:</b> Used to adjust the volume and the display contrast or select desired items.</p>
	<p><b>Programmable Feature (PF):</b> <i>Located on the upper part of the CO button array or on the DSS Console.</i> Assigns the desired button and used to access the stored feature. Mostly used as a One-touch Dialing button. (Only the "F and number" may be shown on some telephones.)</p>		<p><b>MODE:</b> Used to shift the display to access various features.</p>
	<p><b>SELECT:</b> Used to select the displayed item or to call the displayed phone number.</p>		<p><b>SHIFT:</b> Used to access the second level of Soft button features.</p>
	<p><b>ENTER:</b> Used to confirm the selected item.</p>		<p><b>CANCEL:</b> Used to cancel the selected item.</p>

### Customized Buttons

If the term is in parentheses like (Account) in this section, it means a flexible button has been made into an "Account" button. To customize, refer to "3.1.3 Customizing the Buttons".

Buttons	Feature
Loop-CO (L-CO)	Used to access an idle CO line for making outside calls. Incoming outside calls from any CO line arrive at this button.
Group-CO (G-CO)	Used to access an idle CO line in a specified CO line group for making outside calls. Incoming calls from CO lines in the assigned CO line group arrive at this button.

Buttons	Feature
Single-CO (S-CO)	Used to access a specified CO line for making or receiving outside calls.
Direct Station Selection (DSS)	Used to access an extension with one touch. It is also possible to be changed to the other feature button.
One-touch Dialing	Used to access a desired party or system feature with one touch.
Group Directory Number (G-DN)	Used to access a specified incoming call distribution group for making or receiving calls.
Message	Used to leave a message waiting indication or call back the party who left the message waiting indication.
Message for another extension	Used to have a Message button for another extension.
Call Forwarding (FWD)/Do Not Disturb (DND)—Both calls	Used to forward all calls to a specified destination or refuse.
FWD/DND—Outside calls	Used to forward CO line calls to a specified destination or refuse.
FWD/DND—Intercom calls	Used to forward intercom calls to a specified destination or refuse.
Group FWD—Both calls	Used to forward all the calls to your group to a specified destination.
Group FWD—Outside calls	Used to forward the CO line calls to your group to a specified destination.
Group FWD—Intercom calls	Used to forward the intercom calls to your group to a specified destination.
Account	Used to enter an account code.
Conference	Used to establish a multiple party conversation.
Terminate	Used to disconnect the current call and make another call without hanging up.
External Feature Access (EFA)	Used to access special features offered by a host PBX or a telephone company.
Call Park	Used to park or retrieve a call in a preset parking zone.
Call Park (Automatic Park Zone)	Used to park a call in an idle parking zone automatically.
Call Log	Used to show the incoming call information.
Call Log for ICD Group	Used to have a Call Log button for incoming call distribution group.
Log-in/Log-out	Used to switch between the log-in and log-out mode.
Log-in/Log-out of a specified group	Used to have a Log-in/Log-out button for another incoming call distribution group.
Log-in/Log-out for all groups	Used to have a Log-in/Log-out button for all groups.
Hurry-up	Used to transfer the longest waiting call in the queue of an incoming call distribution group to the overflow destination.
Wrap-up	Used to switch the wrap-up status, Ready and Not Ready mode.
System Alarm	Used to confirm a PBX error. For more details, consult your dealer.
Time Service (Day/Night/Lunch/Break)	Used to switch the time service mode.
Answer	Used to answer an incoming call.

## 1.1 Before Operating the Telephones

---

<b>Buttons</b>	<b>Feature</b>
Release	Used to disconnect the line during or after a conversation or to complete a Call Transfer.
Toll Restriction (TRS)	Used to change the toll restriction level of other extension users temporarily.
Calling Line Identification Restriction (CLIR)	Used to switch between the CLIP and CLIR services.
Connected Line Identification Restriction (COLR)	Used to switch between the COLP and COLR services.
Headset	Used to talk using the headset.
Time Service Switching Mode (Automatic/Manual)	Used to switch the time service mode, Automatic or Manual.
Two-way Record	Used to record a conversation into your own mailbox.
Two-way Transfer	Used to record a conversation into the mailbox of a specific extension.
One-touch Two-way Transfer	Used to record a conversation into the mailbox of a specific extension with one touch.
Live Call Screening (LCS)	Used to monitor your own voice mailbox while an incoming caller is leaving a message and, if desired, intercept the call.
Voice Mail Transfer	Used to transfer a call to the mailbox of a specified extension.
Network Direct Station Selection (NDSS)	Used to access an extension connected to other PBXs in the network with one touch.
CTI	Used to access CTI features. For more details, consult your dealer.
Check-in	Used to switch the room status of extensions from Check-out to Check-in.
Check-out	Used to switch the room status of extensions from Check-in to Check-out.

# ◆◆ How to Follow the Steps

An example of system operation is shown below.

◆◆ **Calling Another Extension** Feature title

**Intercom Call**

**PT/SLT/PS**

Off-hook.      Dial extension number or press **DSS**.      Talk.

Operation steps  
The description of the icons are explained on "Icon Descriptions".

- The DSS button light shows the current status as follows:  
**Off:** The extension is idle.  
**Red on:** Your or another extension is using the line.Conditions
- To call using a directory, refer to "1.11.2 Directories".
  - **For quick operation**  
 If you are an operator or dial some extensions frequently, DSS buttons are useful.Hints

**Customizing Your Phone**

- 3.1.2 Settings on the Programming Mode—**Preferred Line Assignment—Outgoing**  
 Select the seized line when going off-hook.
- 3.1.3 Customizing the Buttons  
 Create or edit a Direct Station Selection (DSS) button.

Programming References: The related or required programming is noted.

## ◆◆ Connection Example

This diagram shows you a connection example.

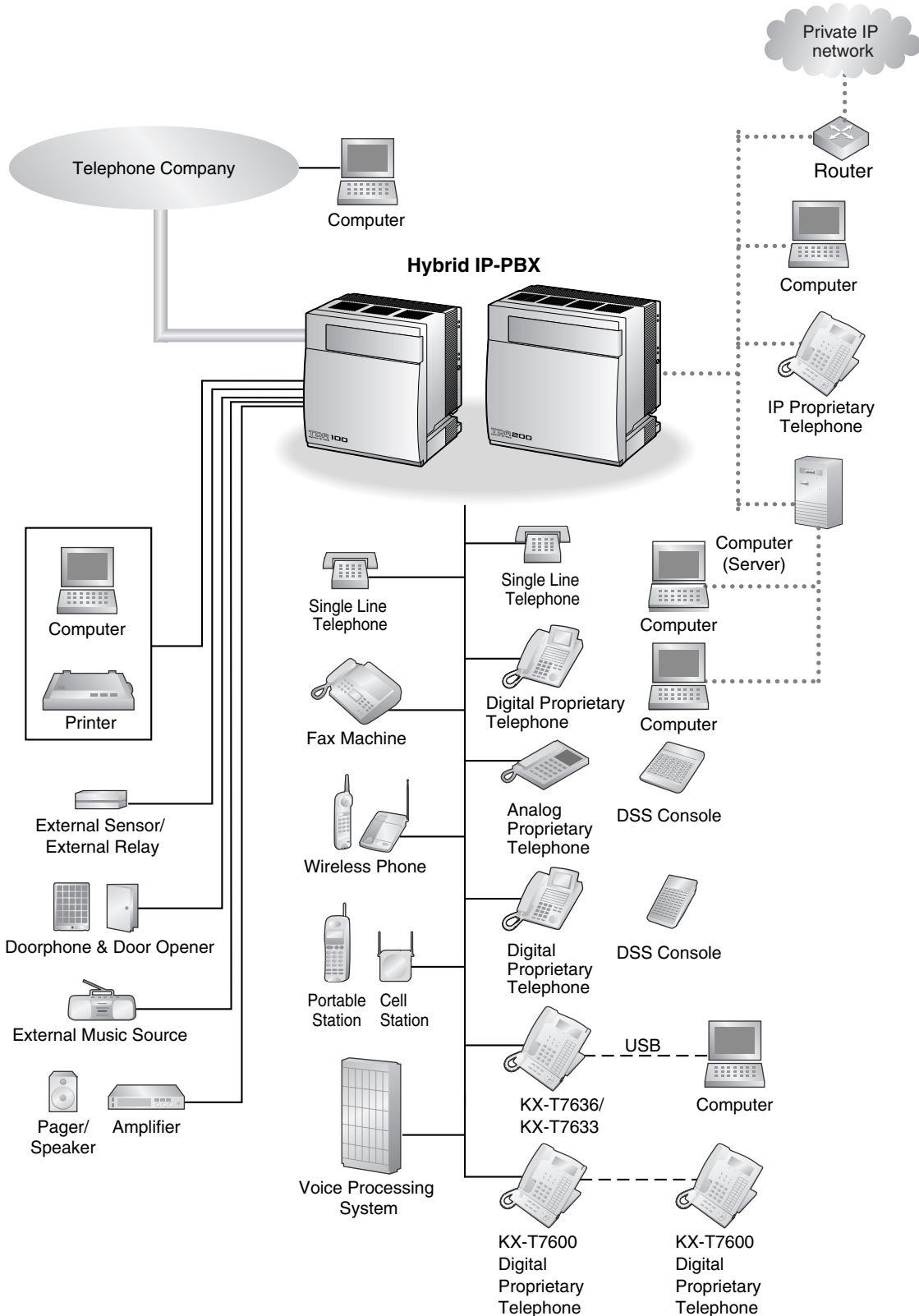

# 1.2 Making Calls

## 1.2.1 Basic Calling

- Calling Another Extension
- Calling an Outside Party
- TIE Line Access
- Account Code Entry

### ◆◆ Calling Another Extension

#### Intercom Call

When your telephone does not access an outside line automatically

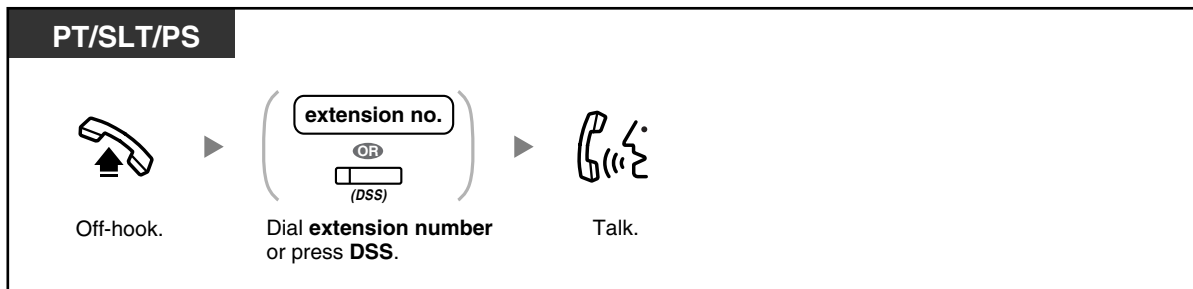

When your telephone accesses an outside line automatically

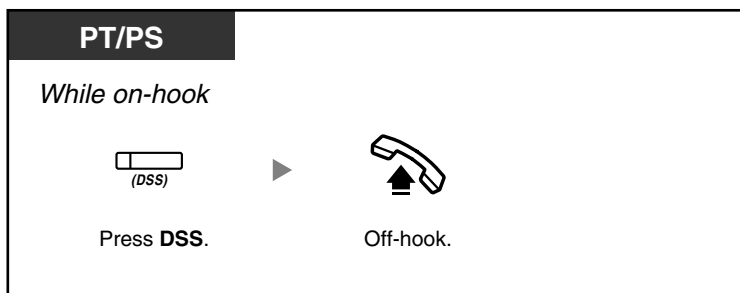
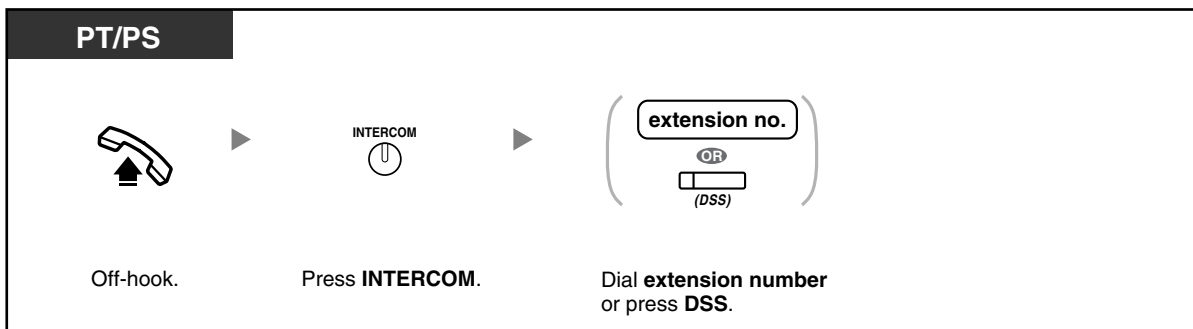

- The DSS button light shows the current status as follows:  
**Off:** The extension is idle.  
**Red on:** Your or another extension is using the line.



- To call using a directory, refer to "1.11.2 Directories".
- **For quick operation**  
If you are an operator or dial some extensions frequently, DSS buttons are useful.



### Customizing Your Phone

- 3.1.2 Settings on the Programming Mode—**Preferred Line Assignment—Outgoing**  
Select the seized line when going off-hook.
- 3.1.3 Customizing the Buttons  
Create or edit a Direct Station Selection (DSS) button.

### Operator Call

You can call an extension or a group assigned as the operator.

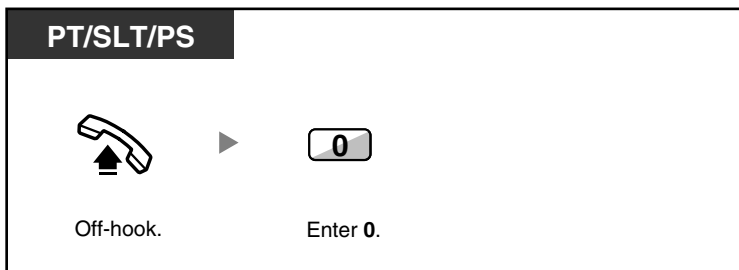

### ◆◆ Calling an Outside Party

You have to seize a CO line before dialing an outside phone number because external calls are made via your PBX.

Select one of the following methods:

#### Automatic Line Access

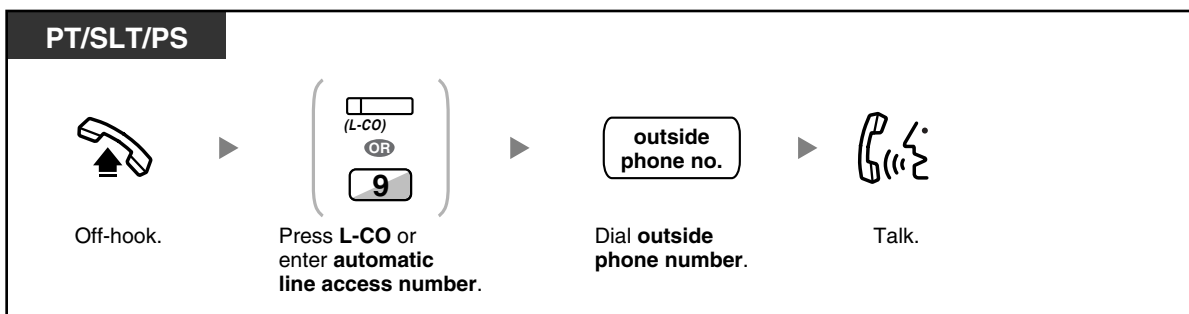



## CO Line Group Access

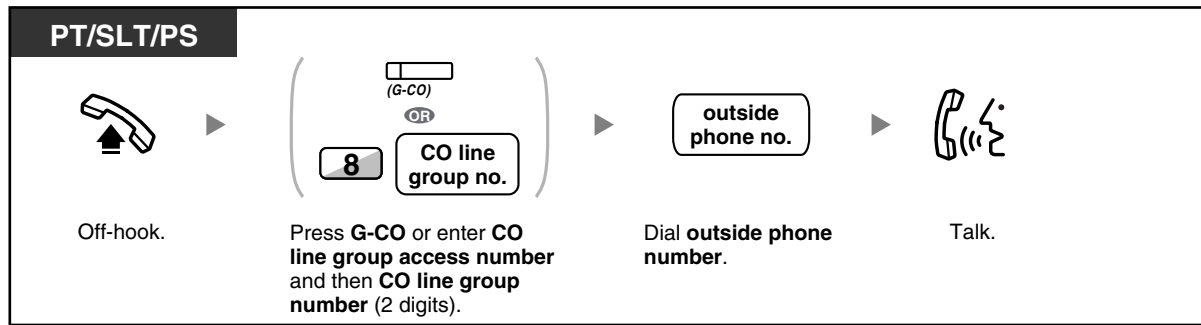

## To select the specified CO line

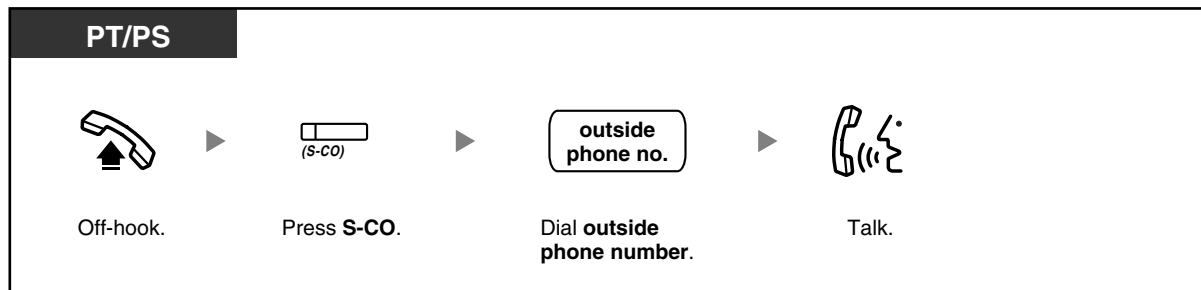

- Each of the S-CO button or G-CO button light shows the current status as follows:
  - Off:** The line is idle.
  - Red on:** The line is in use.
- You may be restricted from making a call to the specified outside party. To make a call, refer to "1.2.6 Calling without Restrictions".



- To confirm number before dialing**, you can enter a phone number and confirm it on the display and then go off-hook. (Predialing)
- To make a call to another party without going on-hook**, press the FLASH/RECALL button. It will re-access the CO line and provide external dial tone. Pressing the Terminate button will provide intercom dial tone. You can dial the new phone number without going on/off-hook.



### Customizing Your Phone

- 3.1.2 Settings on the Programming Mode—**Preferred Line Assignment—Outgoing**  
Select the seized line when going off-hook.
- 3.1.3 Customizing the Buttons  
Create or edit a Loop-CO (L-CO) button, a Group-CO (G-CO) button, a Single-CO (S-CO) button or a Terminate button.

### ◆◆ TIE Line Access

You can access extensions connected to other PBXs in a private network.

#### To call

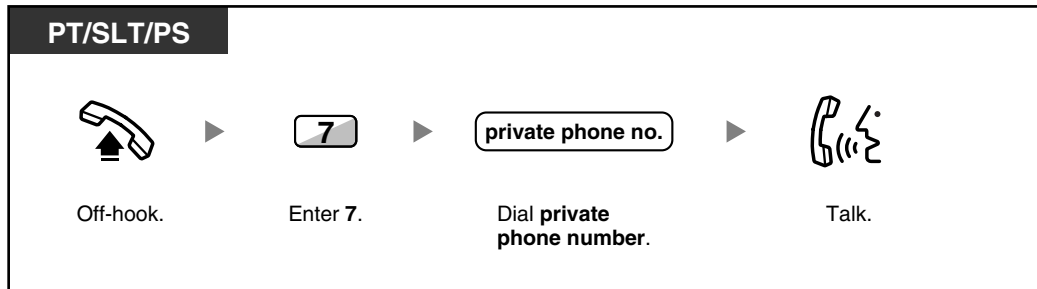

#### To call with one touch

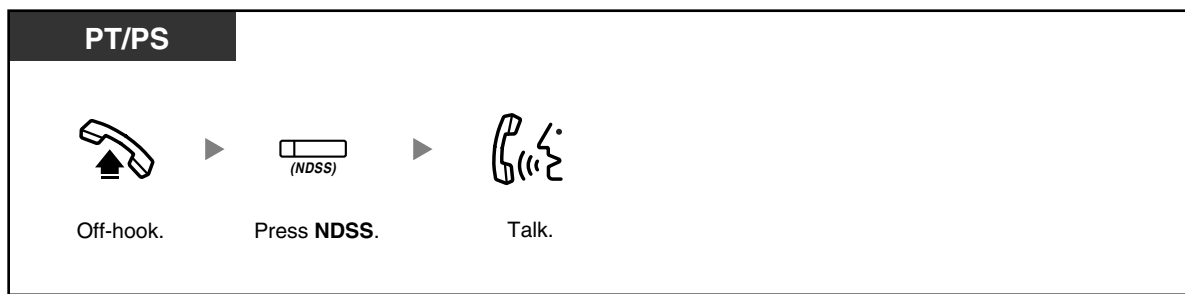

- **To start monitoring another PBX extension after customizing an NDSS button,** go off-hook, press the NDSS button, and go on-hook. The NDSS button light will show the current status as follows:  
**Off:** The extension is idle.  
**Red on:** The extension is busy.



#### Customizing Your Phone

- 3.1.3 Customizing the Buttons  
Create or edit a Network Direct Station Selection (NDSS) button.

## ◆◆ Account Code Entry

You may give a specified account code to extension users and check their telephone usage. You can specify an account code for each client and check the call duration.

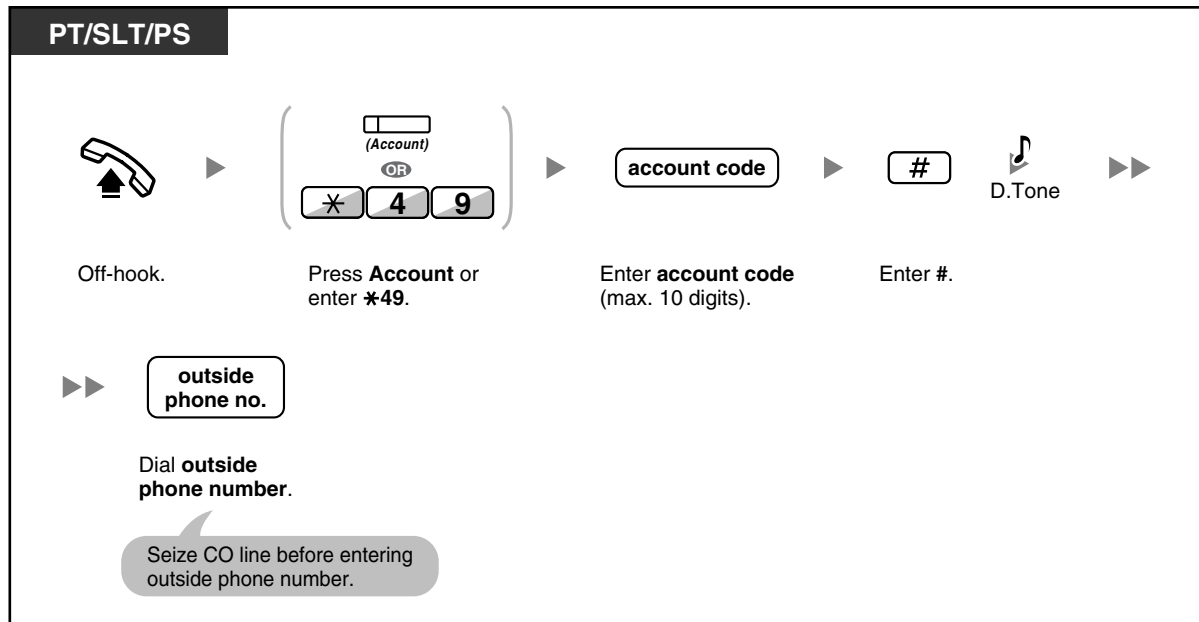

- **A Panasonic proprietary telephone extension user** can enter an account code during a conversation and when hearing reorder tone after the other party hangs up.
- Account codes may use the digits "0" through "9".
- **If you enter the wrong code**, press the "\*" key and re-enter the account code.



- You may not be able to make an outside call without an account code. Entry mode is assigned to each user. Ask your manager for your mode.
- **For your convenience**, you can store the code with the phone number in the memory (e.g., Speed Dialing).



### Customizing Your Phone

- 3.1.3 Customizing the Buttons  
Create or edit an Account button.

## 1.2.2 Easy Dialing

This is convenient for frequently dialed phone numbers.

- One-touch Dialing
- Personal Speed Dialing
- System Speed Dialing
- Hot Line
- Quick Dialing

## ◆◆ One-touch Dialing

You can store a phone number into the flexible button for one-touch operation.

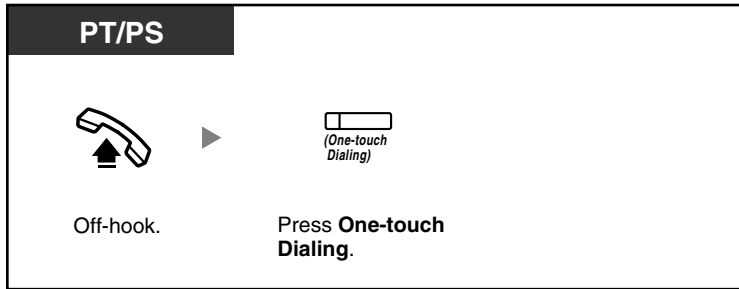

### Customizing Your Phone

- 3.1.3 Customizing the Buttons  
Create or edit a One-touch Dialing button, store the desired phone number or feature number.

## ◆◆ Personal Speed Dialing

You can store numbers at your extension for your personal use. This feature is also known as Station Speed Dialing.

### To store a phone number

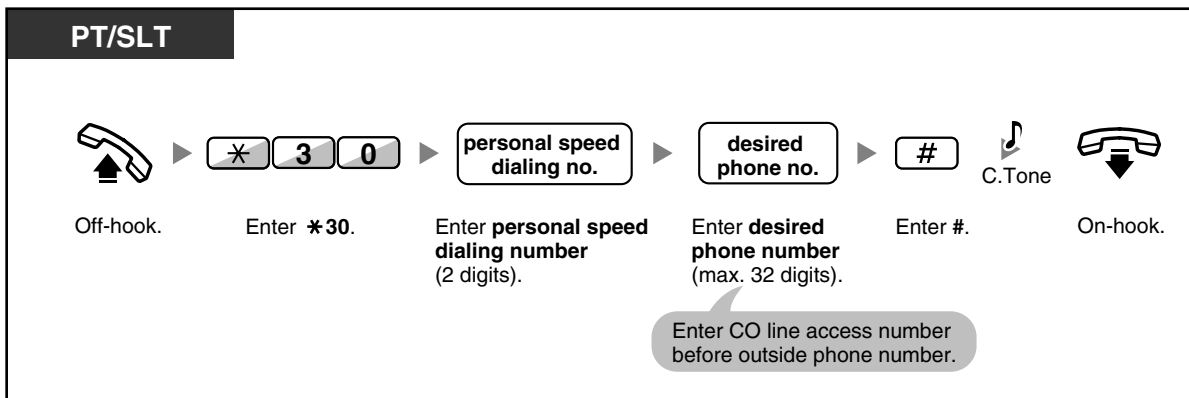

- The maximum number of personal speed dialing numbers (default: 10 numbers, 00-09) can be increased up to 100 numbers. For more details, consult your dealer.

To dial

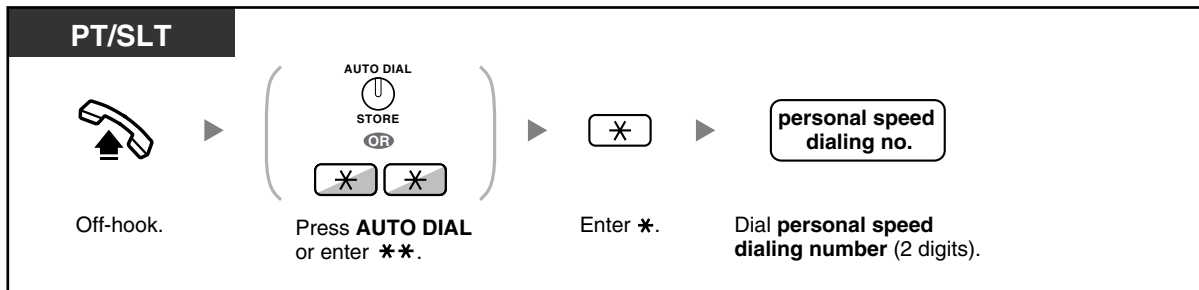

- To call using a directory, refer to "1.11.2 Directories".

◆◆ **System Speed Dialing**

You can make calls using speed dialing numbers stored in the PBX.

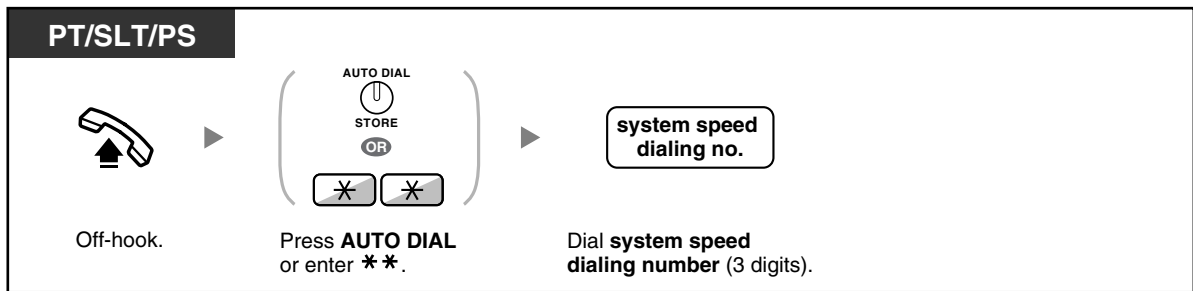

- To call using a directory, refer to "1.11.2 Directories".

◆◆ **Hot Line**

You can make an outside call simply by going off-hook if you have preprogrammed your phone. This feature is also known as Pickup Dialing.

To store a phone number

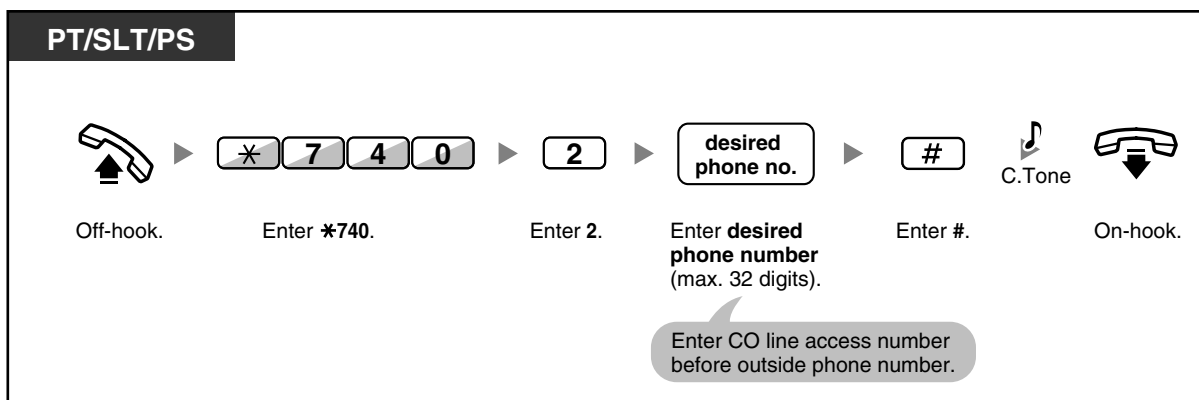

**To set/cancel**

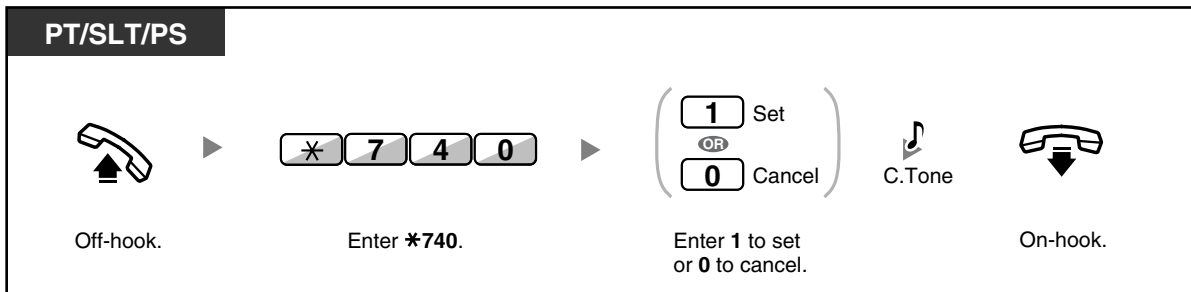

**To dial**



- **To call another party**, dial the desired party's phone number before the preprogrammed number is dialed.
- You should assign the intercom line as the seized line when going off-hook. (Preferred Line Assignment—Outgoing)
- If canceling Hot Line is difficult because this feature is activated immediately after going off-hook, consult your dealer.

**Customizing Your Phone**

- 3.1.2 Settings on the Programming Mode—**Preferred Line Assignment—Outgoing**  
Select the seized line when going off-hook.

**Quick Dialing**

You can make a call simply by pressing the preprogrammed number for quick dialing. For details, consult your manager or dealer.

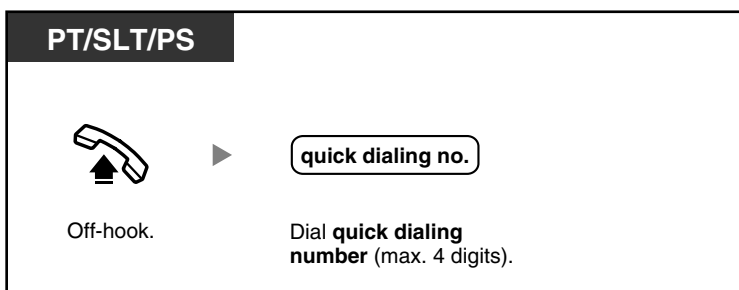

- It is a useful feature for Hotel. For example, to dial the Room Service, dial the digit "3", not the full extension number.

## 1.2.3 Redial

This is convenient when calling the same outside party again.

- Last Number Redial

### ◆◆ Last Number Redial

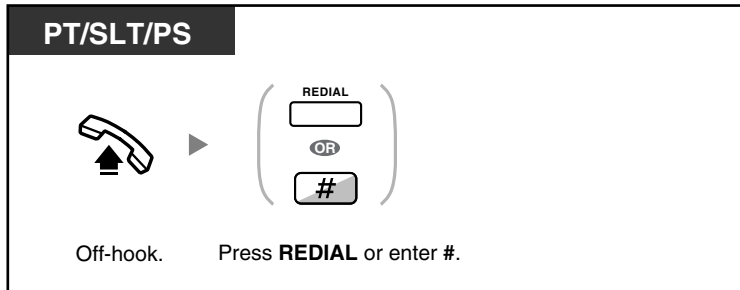

- Up to 32 digits can be stored and redialed.
- After pressing REDIAL, if you hear a busy tone again, press REDIAL to retry.



- **To redial automatically**, press the SP-PHONE button and then the REDIAL button, or press the REDIAL button directly. It will keep trying the busy number until the called party answers or until a specified timeout (Automatic Redial). You can perform other tasks during dialing. To cancel, press the FLASH/RECALL button. Some CO lines may not support this feature.

## 1.2.4 When the Dialed Line is Busy or There is No Answer

- Automatic Callback Busy
- Call Waiting
- Message Waiting
- Executive Busy Override
- Call Monitor
- DND Override

### ◆◆ Automatic Callback Busy

You can set the telephone to receive callback ringing:

- when a dialed extension becomes idle.
- when your desired CO line that is in use by another extension becomes idle.

You cannot set Automatic Callback Busy for a busy party outside of the PBX.

When you answer the callback ringing:

- For an outside call: The line is seized.
- For an intercom call: The called extension starts ringing automatically.

**To set (for both extension and CO line)**

**PT/SLT/PS**

*While hearing a busy tone*



Enter 6.                      On-hook.

**To answer the callback ringing from an idle extension**

**PT/SLT/PS**

*While hearing a callback ringing*



Off-hook.                      Talk.

**To answer the callback ringing from an idle CO line**

**PT/SLT/PS**

*While hearing a callback ringing*

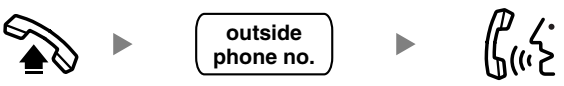

Off-hook.                      Dial **outside phone number.**                      Talk.

- If you do not answer the callback ringing within 10 seconds, this feature will be canceled.

**Automatic Callback Busy Cancel**

**PT/SLT/PS**

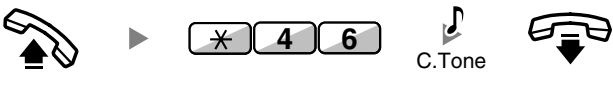

Off-hook.                      Enter **\*46.**                      C.Tone                      On-hook.



## ◆◆ Call Waiting

You can inform the called party that your call is waiting.  
This feature is also known as Busy Station Signaling (BSS).

**PT/SLT/PS**

*While hearing a busy tone*

**1**

Enter 1.



- **Depending on the other party's telephone**, the "Off-hook Call Announcement (OHCA)" and the "Whisper OHCA" features can be used. You can talk to the other party through the speaker and the microphone (OHCA) or you only send a call announcement through the handset (Whisper OHCA), if they are having another conversation using the handset. Refer to "1.7.3 Call Waiting/Off-hook Call Announcement (OHCA)/Whisper OHCA". For telephones capable of using the OHCA and Whisper OHCA features, consult your dealer.

## ◆◆ Message Waiting

### ◆ For a caller

When the called extension is busy or does not answer your call, you can leave a notification so that the called party may call you back.

### ◆ For a called extension

As a message receiver, the Message button light or Message/Ringer Lamp lets you know that a call has been received. If you receive notification, you can call back the caller by a simple operation.

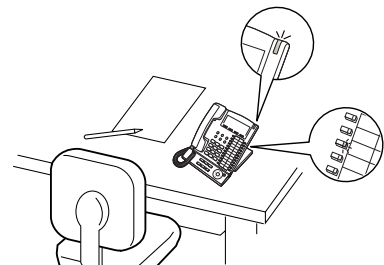

### ◆ For a caller

#### To leave a message waiting indication

**PT/SLT/PS**

*When the called extension is busy or does not answer*

MESSAGE

OR

**4**

C.Tone

On-hook.

Press **MESSAGE** or enter **4**.

### To leave/cancel a message waiting indication

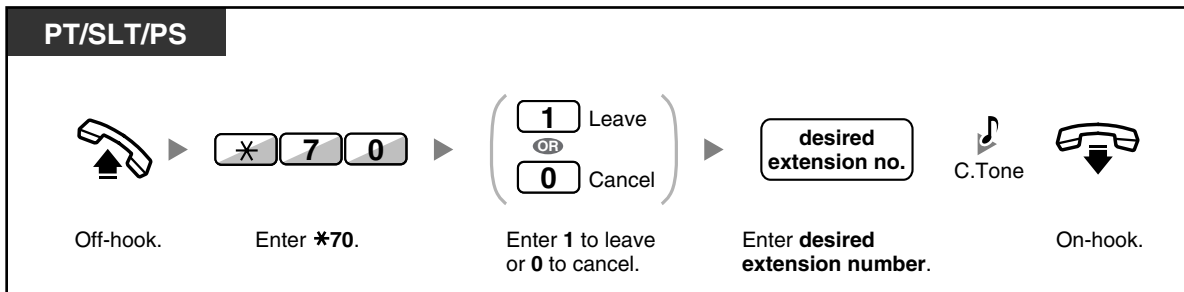

#### ◆ For a called extension

### To check the left message and call back

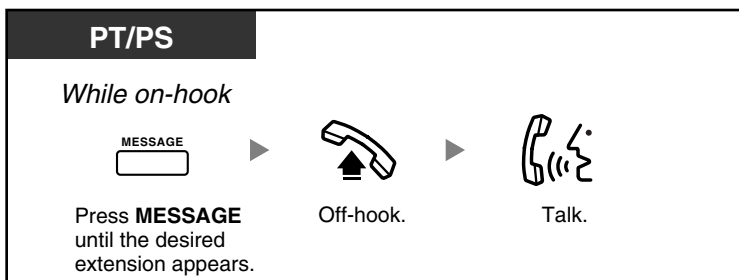

### To call back

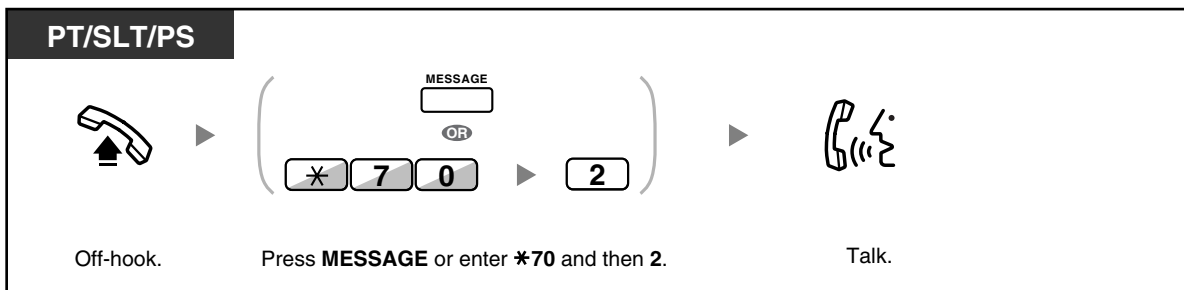

### To clear message waiting indications left on your extension

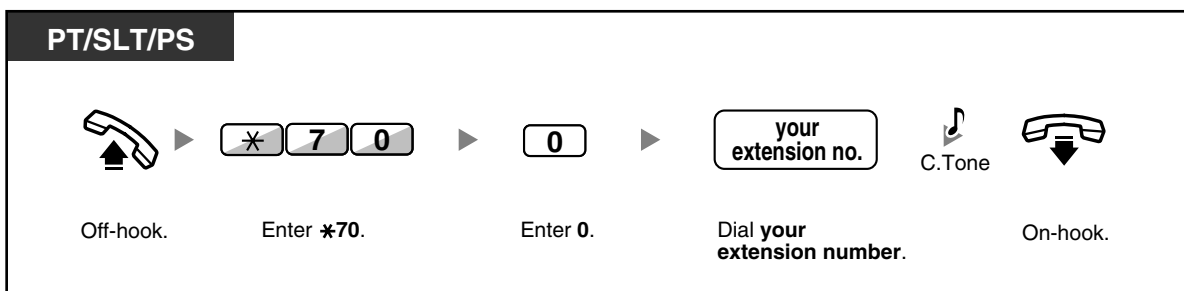



- The Message button light or Message/Ringer Lamp shows the current status as follows:  
**Off:** No message  
**Red on:** You have a message.
- The display shows the messages starting with the most recent call.
- At a called extension, the MESSAGE button allows you to clear message waiting indications if you do not want to call the callers back. To clear, press the MESSAGE button and then press the soft button.
- On your PT, you can establish one or more "Message for another extension" buttons. These buttons can accept the message waiting notification of other extensions or various incoming call distribution groups. In other words, you can monitor the message waiting notifications of other telephones.
- This feature is also available for single line telephone extension users with a message waiting light. Even if they do not have a message waiting light, they may receive a special dial tone as notification, if required.



### Customizing Your Phone

- 3.1.3 Customizing the Buttons  
 Create or edit a Message button or Message for another extension button.

## ◆◆ Executive Busy Override

The preprogrammed extension can call someone who is busy on the telephone and establish a three-party conversation.

### To join an intercom call

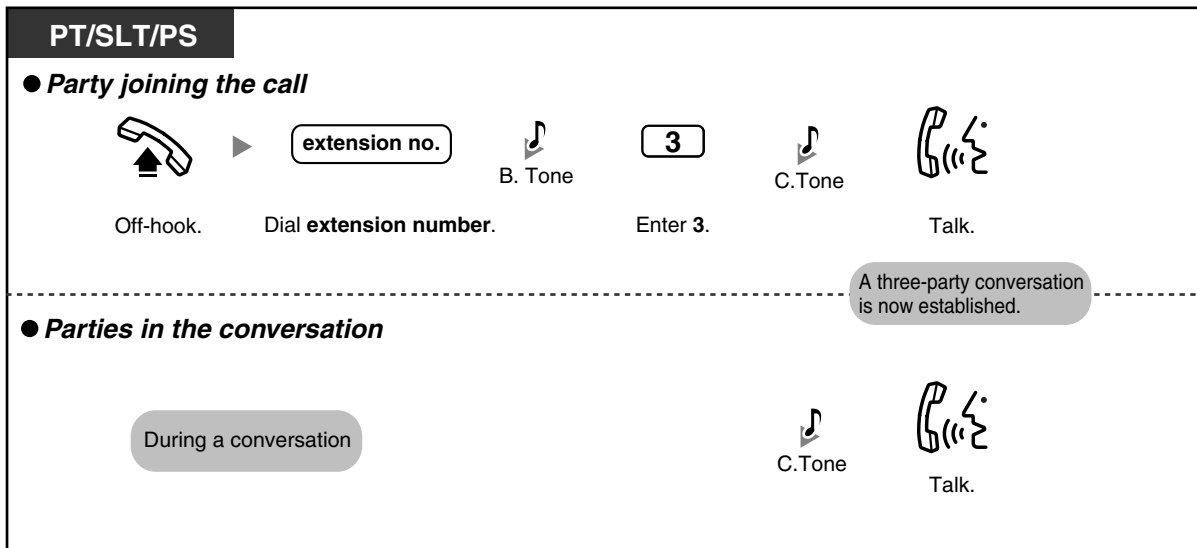

To join an outside call

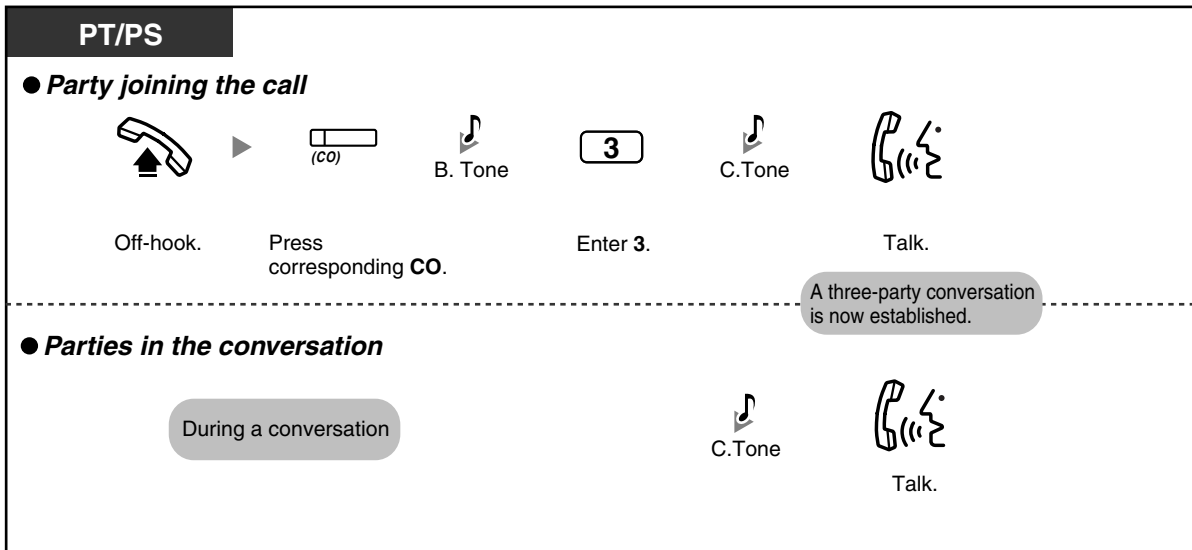

To leave a three-party conversation with an outside party and let the two other parties talk (originating extension only)

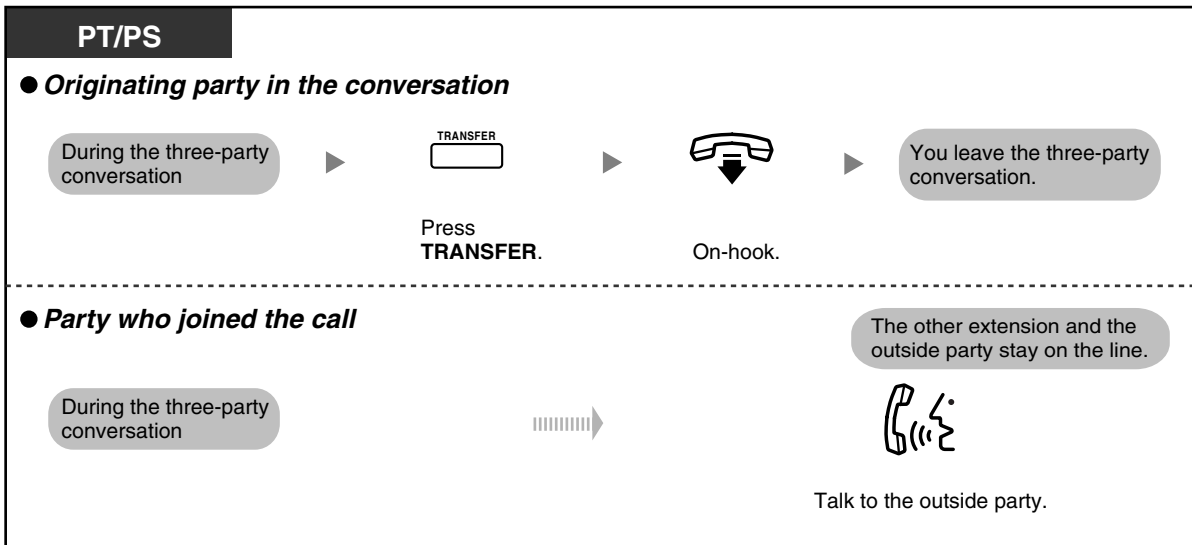

- The third party can leave the conversation by simply going on-hook.
- It is necessary to enable your extension to transfer calls to outside lines through COS programming. It is also necessary that Executive Busy Override is enabled at the joined extension. For more details, consult your dealer.

◆ For the originating extension

To talk to each party alternately

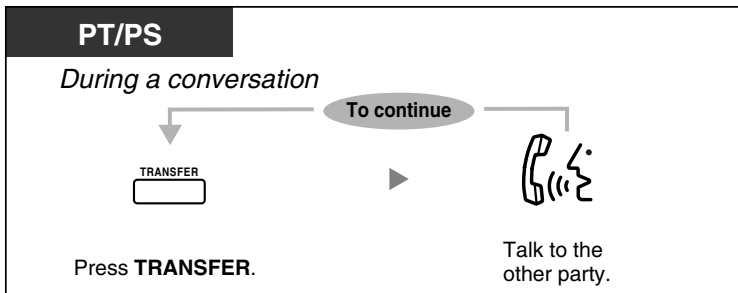

- You can also deny others the possibility of joining your conversation (Default: Allow). Refer to "1.7 Extension Settings".

◆◆ Call Monitor

The preprogrammed extension can monitor another extension.

To monitor

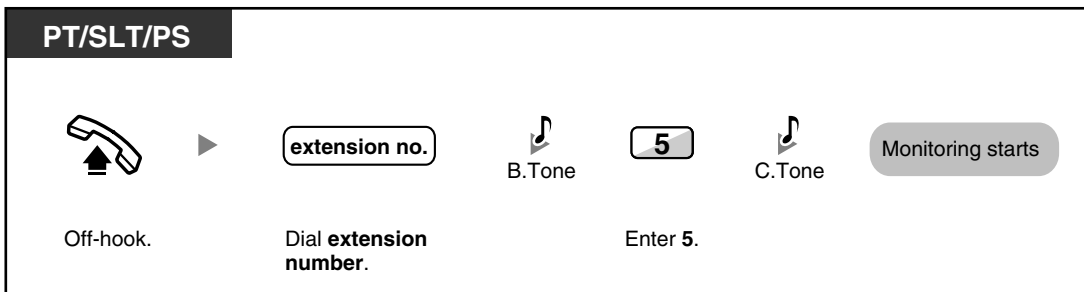

◆◆ DND Override

The preprogrammed extension can call someone who has set the DND feature.

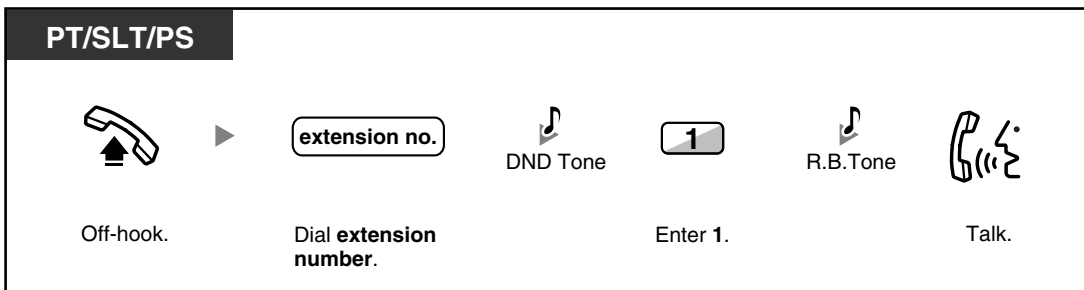

## 1.2.5 Alternate Calling—Ring/Voice



The caller can alternate the alerting method, either ring or voice, when making an intercom call. On the other hand, any extension can set the alerting method, either ring or voice, when receiving an intercom call.

**Ringing (Default):** You can call the other party with a ring tone.

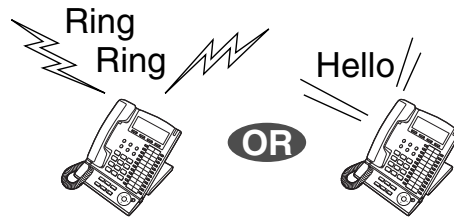
**Voice-Calling:** You can talk to the other party immediately after confirmation tone.



### To change the method

PT/SLT/PS		
<i>After dialing</i>		
		
Enter *.		Talk.



- If the called party uses a single line telephone or portable station, Voice-Calling is not available.
- This feature is not available when the called party's telephone is in the Voice Call Deny mode.



### Customizing Your Phone

- 3.1.2 Settings on the Programming Mode—**Alternate Receiving—Ring/Voice**  
Select the alerting method, either ring or the other party's voice.

## 1.2.6 Calling without Restrictions

- Remote COS Access

### ◆◆ Remote COS Access

You can use your calling privileges (Class of Service) at another extension. You may override restrictions which have been set. To use this feature, an original extension number and an extension PIN (Personal Identification Number) are required. You can make a call by entering a verified code and verified code PIN. For the available verified code, ask your manager.

#### To call (Walking COS)

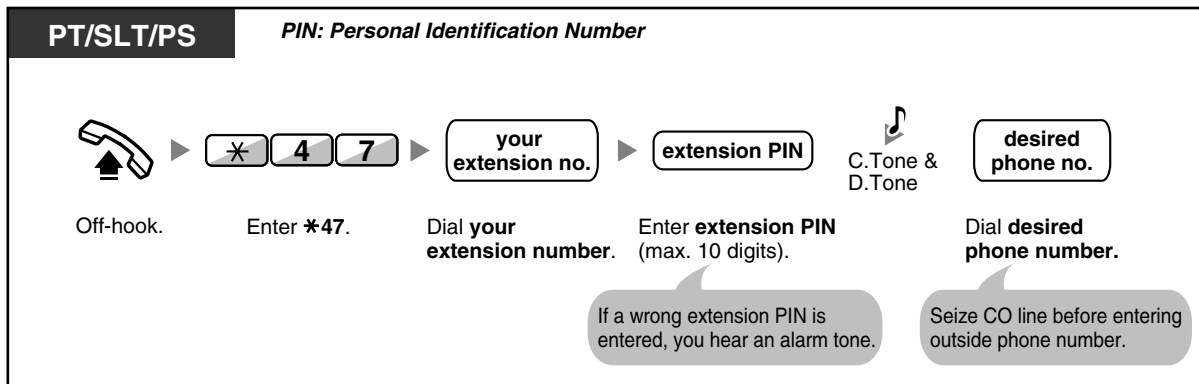

#### To call (Verified Code Entry)

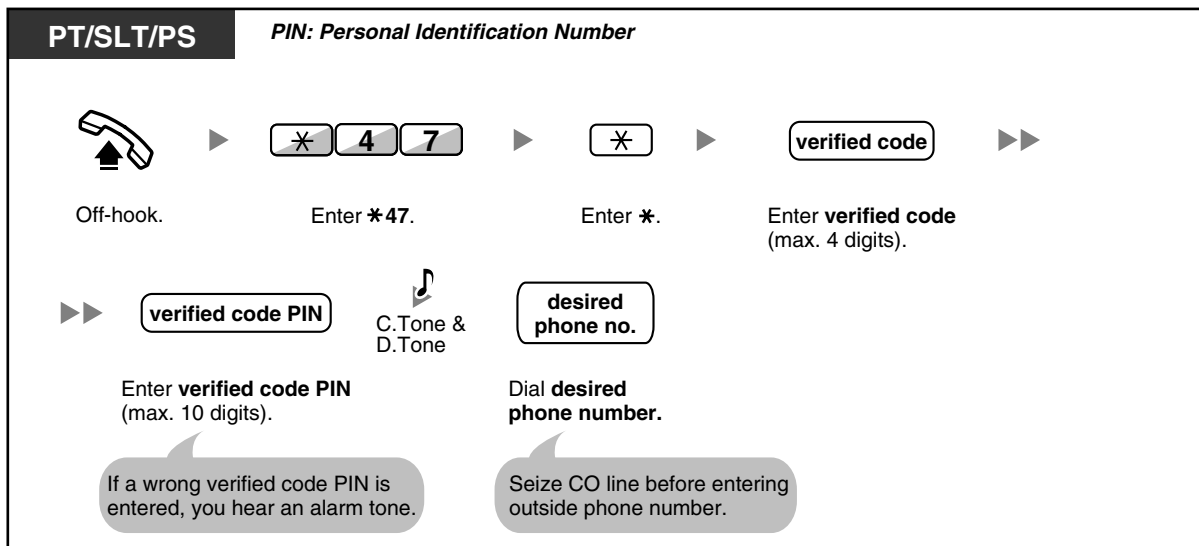

## 1.2.7 Direct Inward System Access (DISA)

- Calling through DISA

### ◆◆ Calling through DISA

When outside callers access extensions in the PBX, a prerecorded message greets the caller and gives information about how to access an extension. You do not need the operator's assistance.

You may be able to access system features or call an outside party with your password depending on the security mode. Ask your manager for the mode assigned to your PBX.

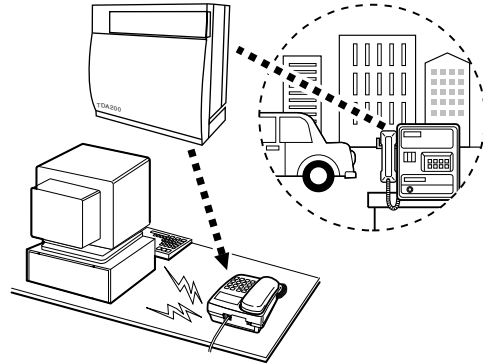

### To call an extension

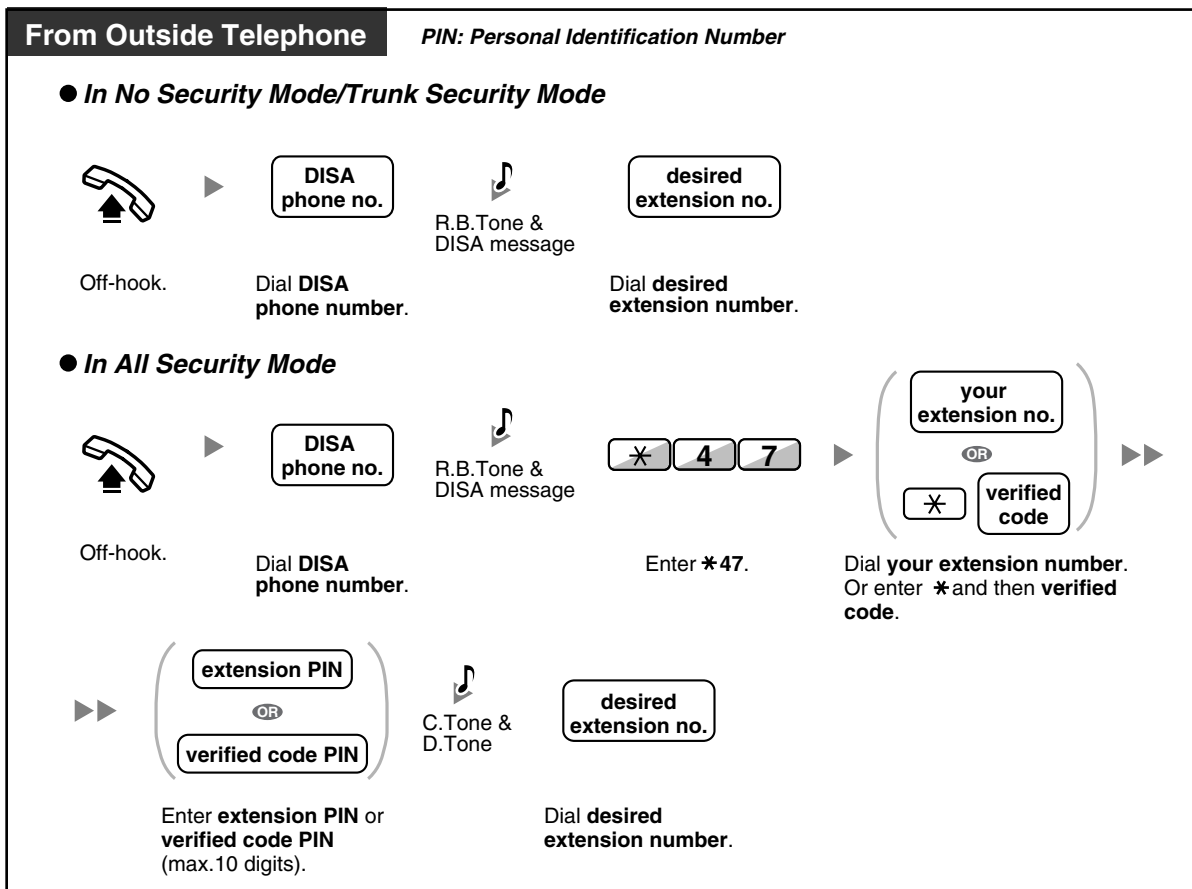



To call an outside party

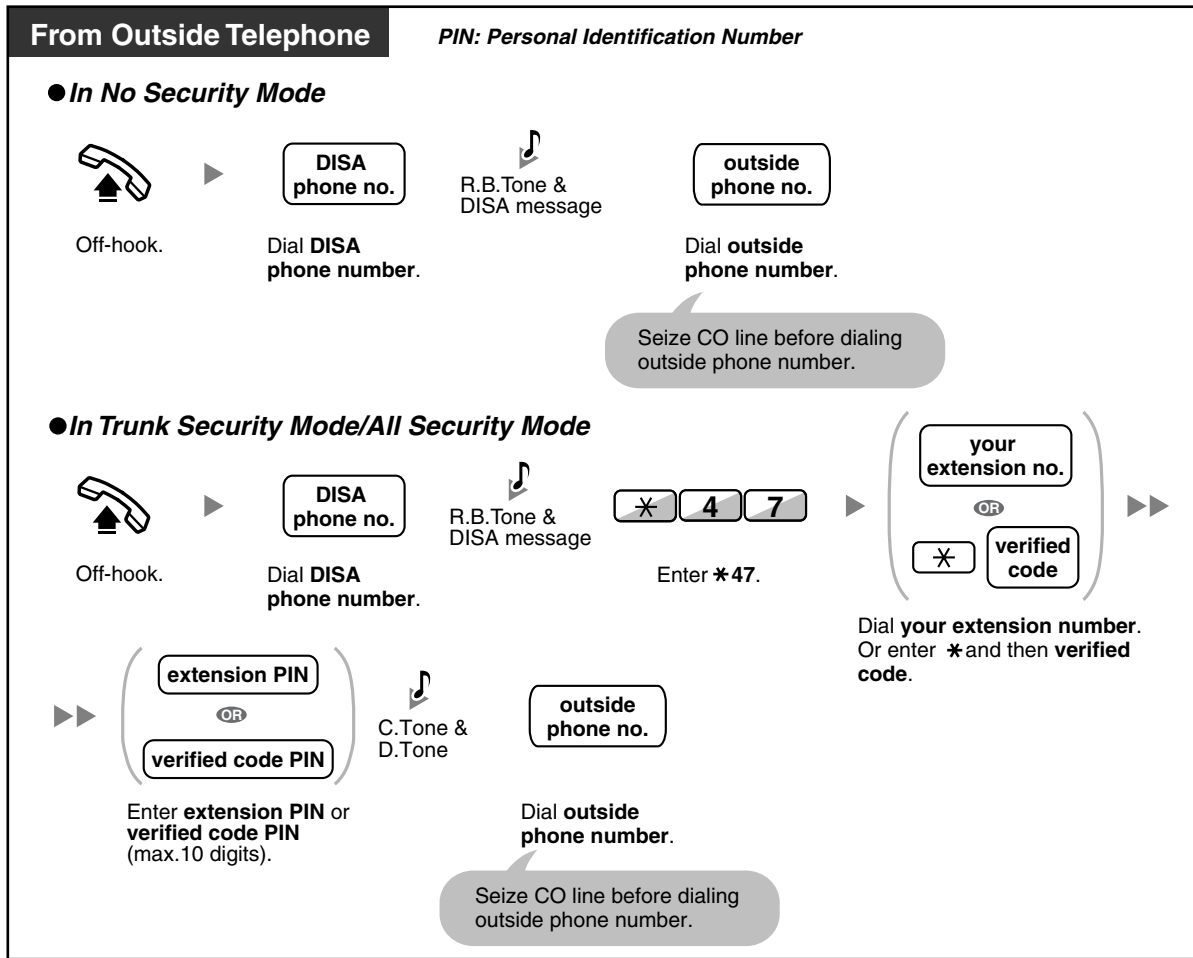

To retry

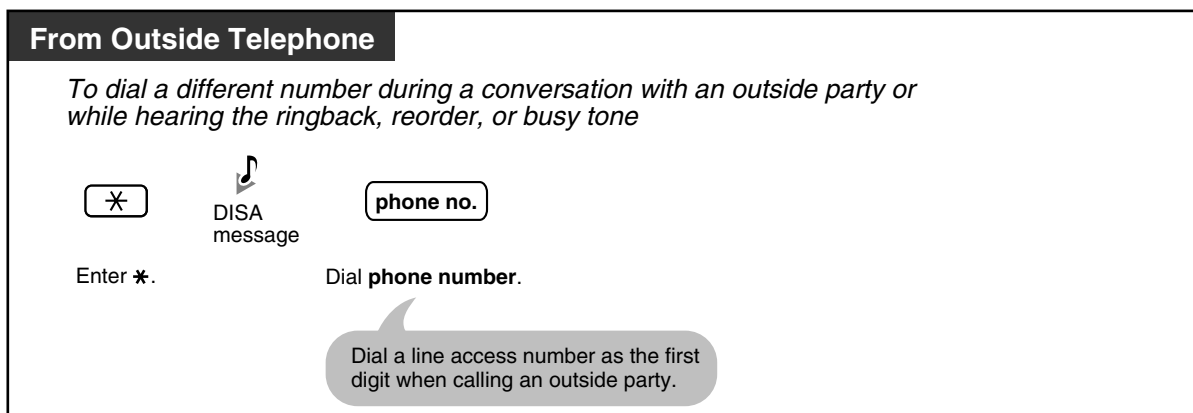



- **WARNING**  
When you enable the Outside-to-Outside Call feature of DISA, and a third party discovers the password (verified code PIN/extension PIN) of the PBX, there will be a risk that they will make fraudulent phone calls using the telephone line, and the cost will be charged to your own account. In order to avoid this problem, we strongly recommend the following points:
  - a) Carefully maintain the secrecy of the PIN.
  - b) Specify a complicated PIN as long and random as you can make it.
  - c) Change the PIN frequently.
- **Time limit**  
Both parties will hear an alarm tone fifteen seconds before the specified time limit. To extend, press any dial button except ✖.
- **If Built-in Automated Attendant service is set**, you can access the desired extension simply by pressing a single digit (0-9) from the options given the prerecorded message.

## 1.2.8 Remote Setting

You can set the following features on your telephone from another extension or through DISA.

- Call Forwarding (FWD)/Do Not Disturb (DND)
- Changing the Log-in/Log-out Status of Extensions
- Absent Message
- Extension Lock
- Time Service—Changing the Time Mode (Day/Night/Lunch/Break)

### From another extension

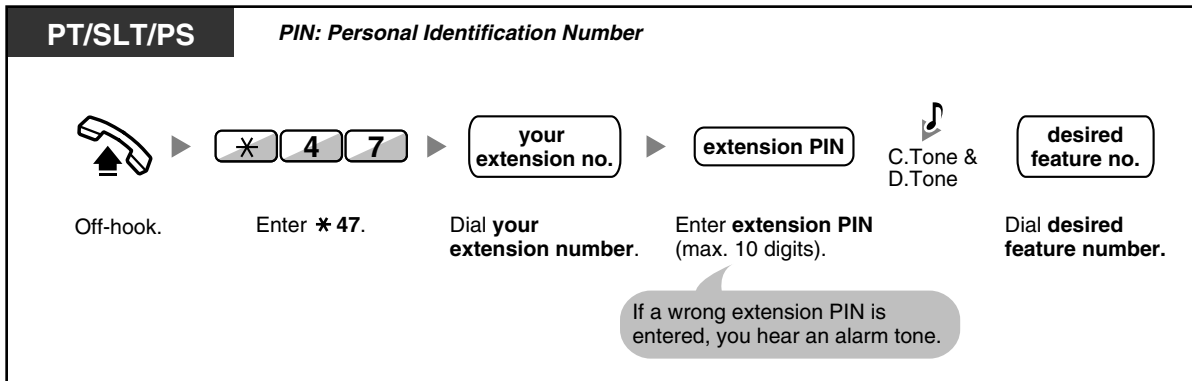

## Through DISA

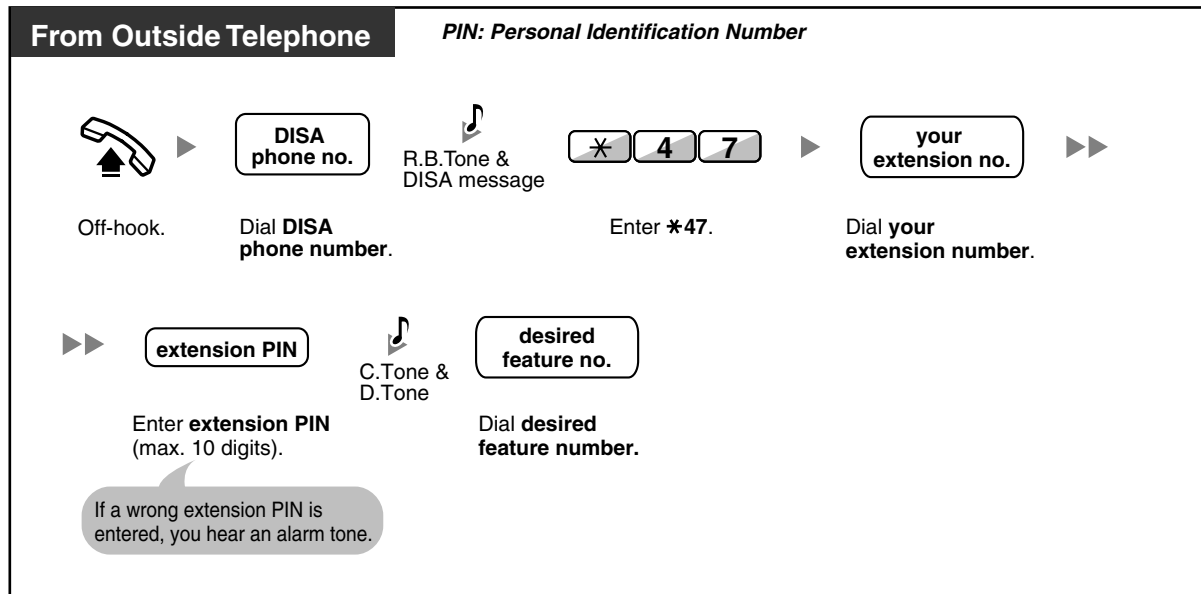

# 1.3 Receiving Calls

## 1.3.1 Answering Calls

**PT/SLT/PS**



Off-hook.                      Talk.

Select one of the following methods:

- Lift the handset to receive the preferred line.  
(Default: Ringing line is selected.)
- Press the SP-PHONE button.
- Press the flashing CO, INTERCOM or G-DN button directly.
- Press the ANSWER button.



- The G-DN button light shows the current status as follows:  
**Off:** Idle  
**Green on:** The line is in use. (You are using the line.)  
**Red on:** Your extension is in Log-out mode from the incoming call distribution group.



### Customizing Your Phone

- 3.1.2 Settings on the Programming Mode—  
**Preferred Line Assignment—Incoming**  
Select the seized line when going off hook.  
**Alternate Receiving—Ring/Voice**  
Select the Calling method, either ring or the other party's voice.
- 3.1.3 Customizing the Buttons  
Create or edit a Group Directory Number (G-DN) button.

## 1.3.2 Hands-free Answerback

You can answer an incoming call without going off-hook as soon as the line is connected. When an intercom call arrives, you will hear the caller talking without the phone ringing. When an outside call arrives, you will hear the caller talking after a preprogrammed number of rings. Hands-free Answerback for outside calls requires System Programming. Consult your dealer.



### To set/cancel



- The AUTO ANS button light shows the current status as follows:
  - Off:** Not set
  - On:** Set
- For a PS user, refer to "Operating Instructions" for PS.

## 1.3.3 Call Pickup

- Call Pickup
- Call Pickup Deny

### ◆◆ Call Pickup

You can answer an incoming call that is ringing at another extension or group from your phone without leaving your desk.

The following types of pickup are available:

**Group Call Pickup:** Picks up a call within your group.

**Directed Call Pickup:** Picks up a specified extension's call.

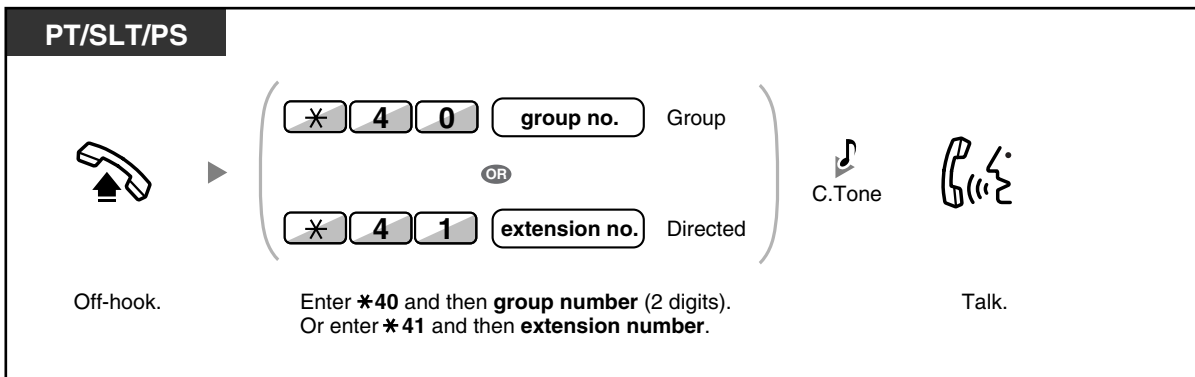

## 1.3 Receiving Calls



- **If you receive a call waiting tone**, you can ask a third party to pick up your second call with Directed Call Pickup.
- If there are multiple incoming calls for the same group, the longest waiting call is received first.



- You can also pickup a call by pressing a flashing DSS button. System programming is required to allow this operation. Consult your dealer.

### ◆◆ Call Pickup Deny

You can deny or allow other people to pick up your calls.

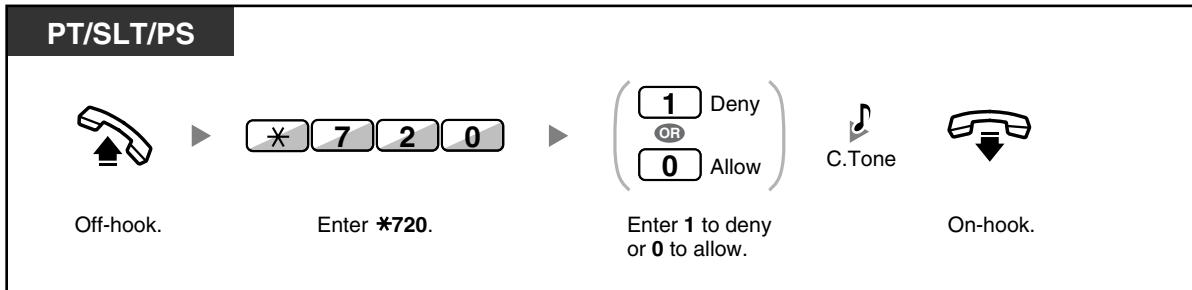

## 1.3.4 Trunk Answer From Any Station (TAFAS)

You can be notified of incoming outside calls through an external speaker. These calls can be answered from any extension.

### Through an external speaker

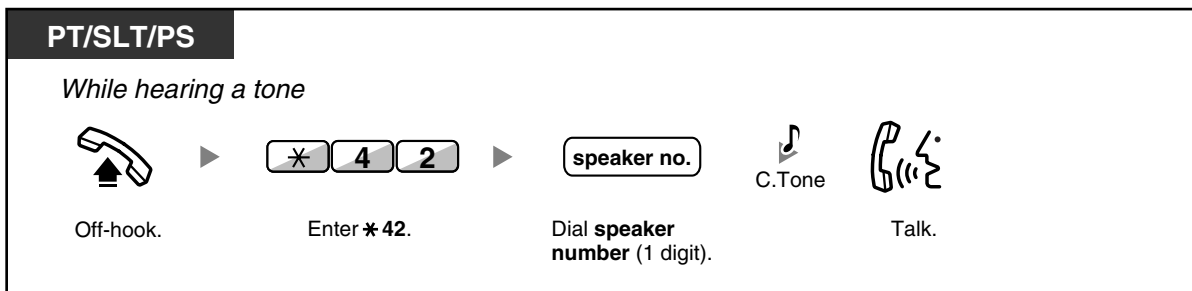

- You can also receive a paging announcement via a speaker with this operation.

## 1.3.5 ANSWER/RELEASE Button

The ANSWER and RELEASE buttons are convenient for operators using headsets. With the ANSWER button, you can answer all incoming calls. With the RELEASE button, you can disconnect the line during or after a conversation, or complete transferring a call.



### To answer



### To transfer a call

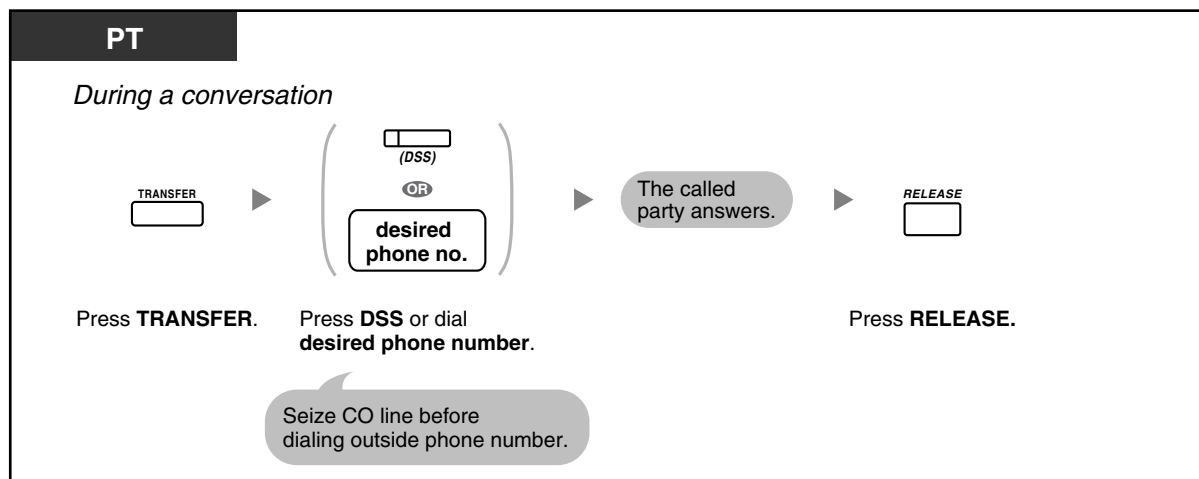

### To talk to a waiting caller

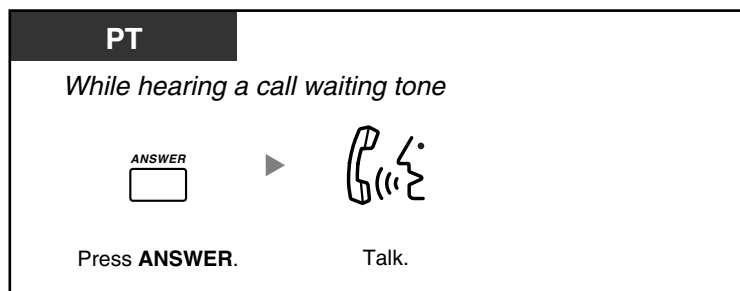

### To transfer an outside call to an extension with a one-touch operation

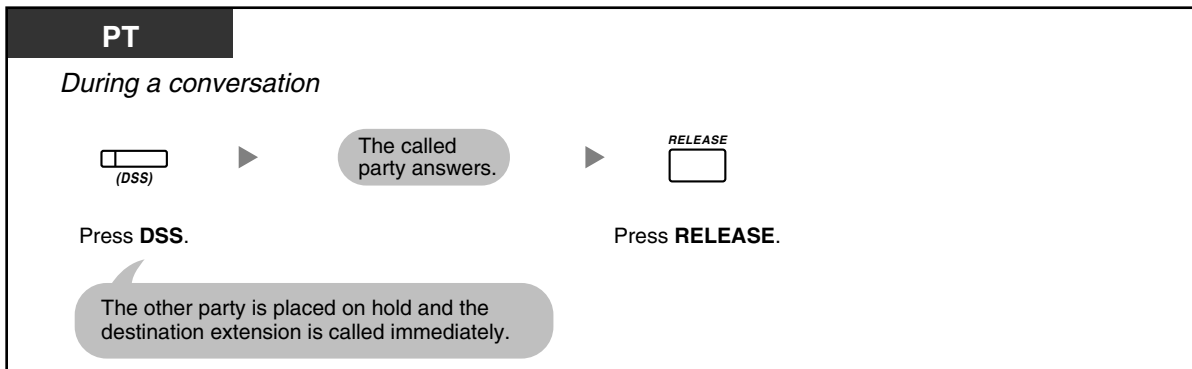

### To end a conversation

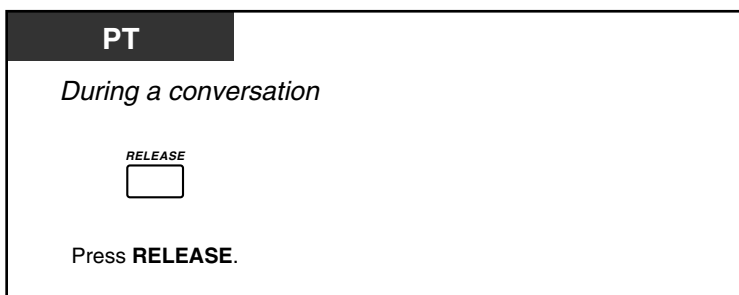

#### Customizing Your Phone

- 3.1.3 Customizing the Buttons  
Create or edit an Answer button or a Release button.



## 1.4 During a Conversation

### 1.4.1 Call Transfer

- Transferring to an Extension on the PBX
- Transferring to an Outside Party Using the PBX Service



- You can transfer a held call without talking by going on-hook. If a call is not retrieved within a specified time, you will hear an alarm as a reminder. And, if an outside call is not answered within a specified time, it is automatically disconnected.
- **If you hear an alarm tone**, the destination extension did not answer the call. Answer the call.

#### ◆◆ Transferring to an Extension on the PBX

##### To transfer

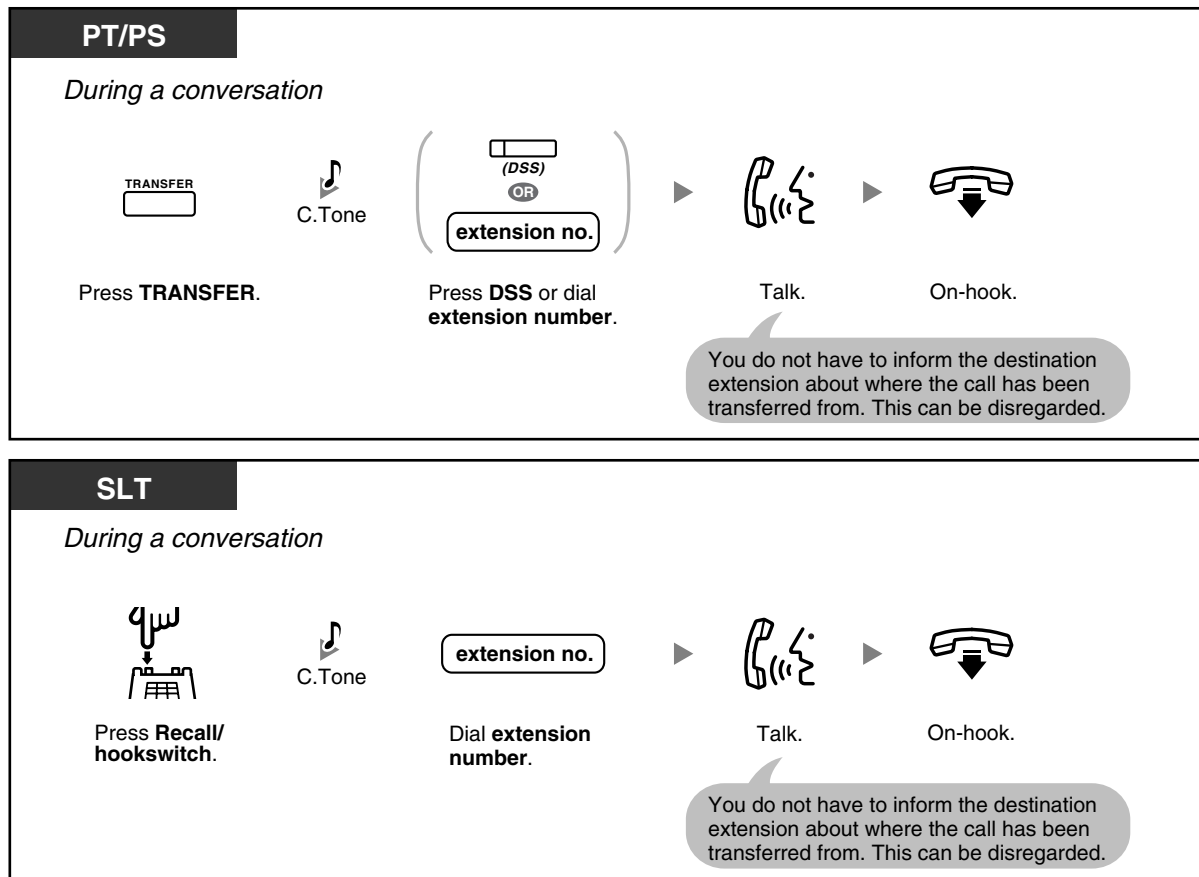

### To transfer with one touch (One-touch Transfer)

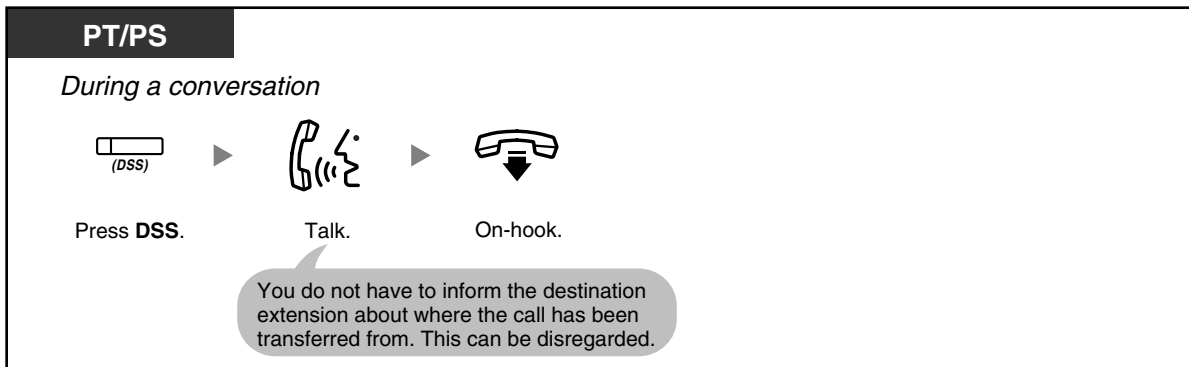

- Even if the transferred party does not answer, you can go on-hook.

### ◆◆ Transferring to an Outside Party Using the PBX Service

Some extensions may be restricted from performing this feature.

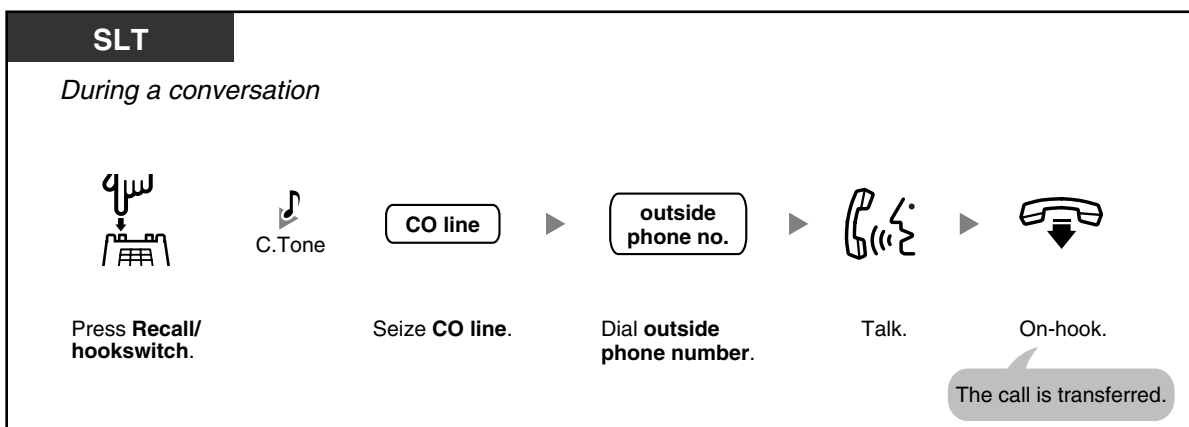
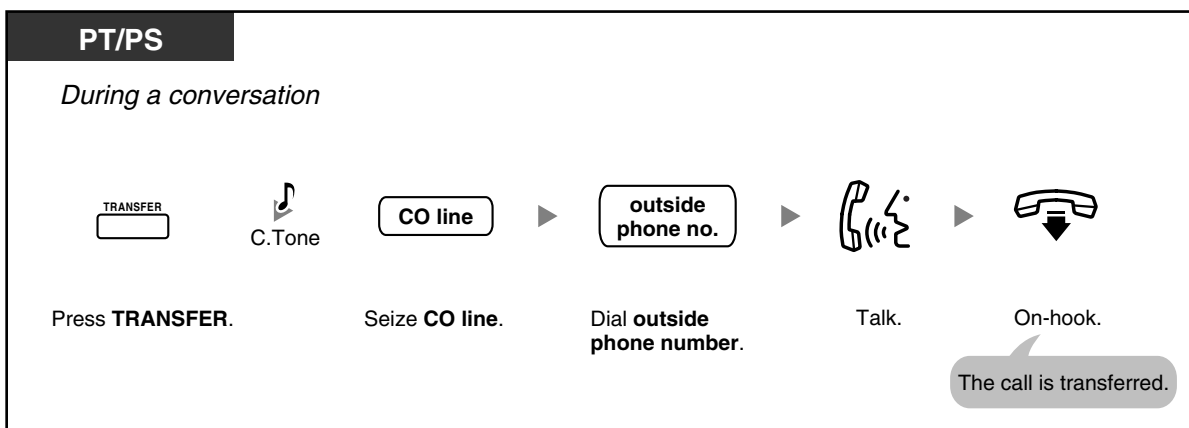



- **Time limit**  
Both the caller and the transferred party will hear an alarm tone fifteen seconds before a specified time period.
- **To return to the held call before the destination answers**, press the TRANSFER button, corresponding CO, G-DN or INTERCOM button, or the hookswitch.



**Customizing Your Phone**

- 3.1.3 Customizing the Buttons  
Create or edit a Direct Station Selection (DSS) button.

## 1.4.2 Call Hold

- Call Hold
- Call Park



- **If a call is not retrieved within a specified time**, you will hear an alarm as a reminder. And, if an outside call is not answered within a specified time, it is automatically disconnected.

### ◆◆ Call Hold

There are two types of hold. The difference between them is that other people can retrieve your held call (Regular Hold) or not (Exclusive Call Hold). As they can be alternated, ask your manager what the current mode is.

#### Call Hold

**PT/PS**

*During a conversation*

Press **HOLD**, or press **TRANSFER** and then enter **\*50**.

C.Tone  
On-hook.

**SLT**

*During a conversation*

Press **Recall/ hookswitch**.

Enter **\*50**.

C.Tone  
On-hook.

## Call Hold Retrieve

**PT/SLT/PS**

- **At the holding extension (Call Hold Retrieve)**

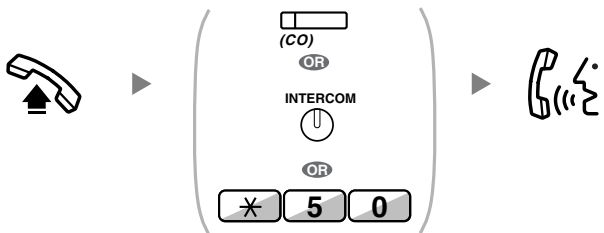

Off-hook. Press flashing **CO** or **INTERCOM**, or enter **\* 50**. Talk.
- **To retrieve an outside call from another extension—only Regular Hold (Call Hold Retrieve—Specified with a held line number)**

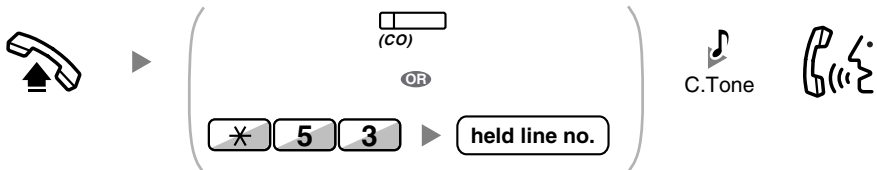

Off-hook. Press **CO**, or enter **\*53** and then **held line number** (3 digits). C.Tone Talk.
- **To retrieve an intercom call or outside call from another extension—only Regular Hold (Call Hold Retrieve—Specified with a holding extension number)**

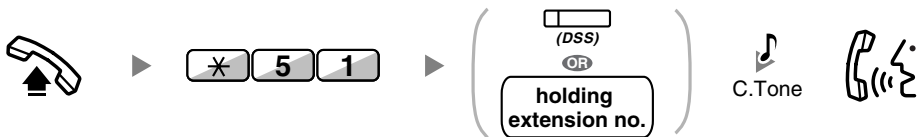

Off-hook. Enter **\*51**. Press **DSS** or dial **holding extension number**. C.Tone Talk.



- The CO or INTERCOM button light shows the current status as follows:

  - Regular Hold mode
    - Flashing green slowly:** Your held call
    - Flashing red:** Another extension's held call
  - Exclusive Call Hold mode
    - Flashing green rapidly:** Your held call
    - Red on:** Another extension's held call
- Hold Mode Change (PT only)**  
 After pressing the HOLD button, if you press the HOLD button again, the status switches from the Regular Hold mode to the Exclusive Call Hold mode or from the Exclusive Call Hold mode to the Regular Hold mode.



- **For simple operation**, you can automatically hold a call by pressing another CO, G-DN or INTERCOM button, only if preprogrammed. **(Automatic Call Hold)** Consult your dealer.

## ◆◆ Call Park

You can put a call on hold in a common parking zone of the PBX so that any extension can retrieve the parked call. You can use this feature as a transferring feature.

A call can be put into either a specified parking zone (Specified) or any idle parking zone (Auto). If a Call Park button and Call Park (Automatic Park Zone) button have been established, you can select either way to park by simply pressing the corresponding button.

When a call is parked automatically, or more than one call has been parked at the same time, you need to specify the parking zone number to retrieve the required call.

### To set

PT/PS

*During a conversation*



(Call Park)

Press **Call Park**.

PT/PS

*During a conversation*



Press **TRANSFER**.

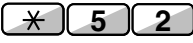

Enter **\*52**.

parking zone no.

 Specified  
 OR  

\*

 Auto



C.Tone



On-hook.

Enter a specified **parking zone number** (2 digits) or press **\*** to park at an idle parking zone automatically.

If you hear a busy tone, enter another parking zone number or press **\*** again.

SLT

*During a conversation*



Press **Recall/hookswitch**.



Enter **\*52**.

parking zone no.



C.Tone



On-hook.

Enter a specified **parking zone number** (2 digits).

If you hear a busy tone, enter another parking zone number.

## Call Park Retrieve

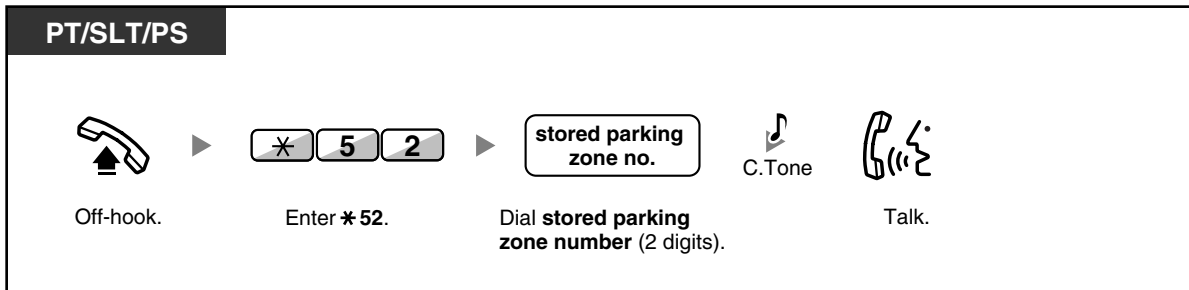
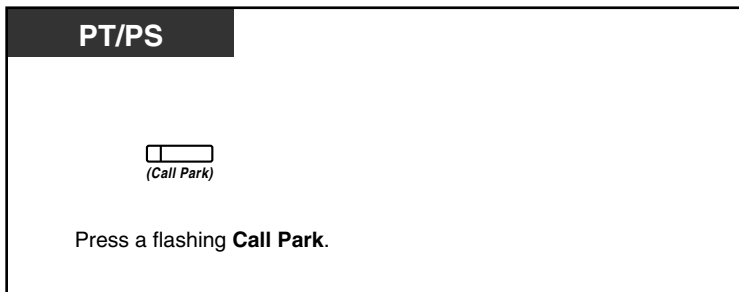

- If a call is parked automatically, confirm the parking zone number on the display.



- **If you hear a reorder tone when retrieving a parked call**, there is no held call. Confirm the stored parking zone number.
- After you park a call, you can perform other operations.



### Customizing Your Phone

- 3.1.3 Customizing the Buttons  
Create or edit a Call Park button or Call Park (Automatic Park Zone) button.

### 1.4.3 Call Splitting

When talking to one party while the other party is on hold, you can swap the calls back and forth (alternately).

#### To alternate between the parties leaving one party on hold temporarily

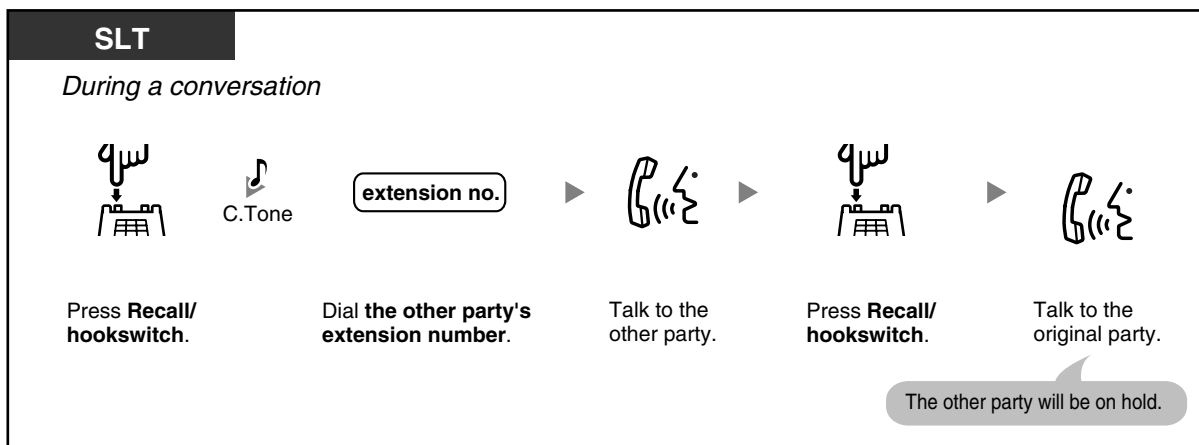
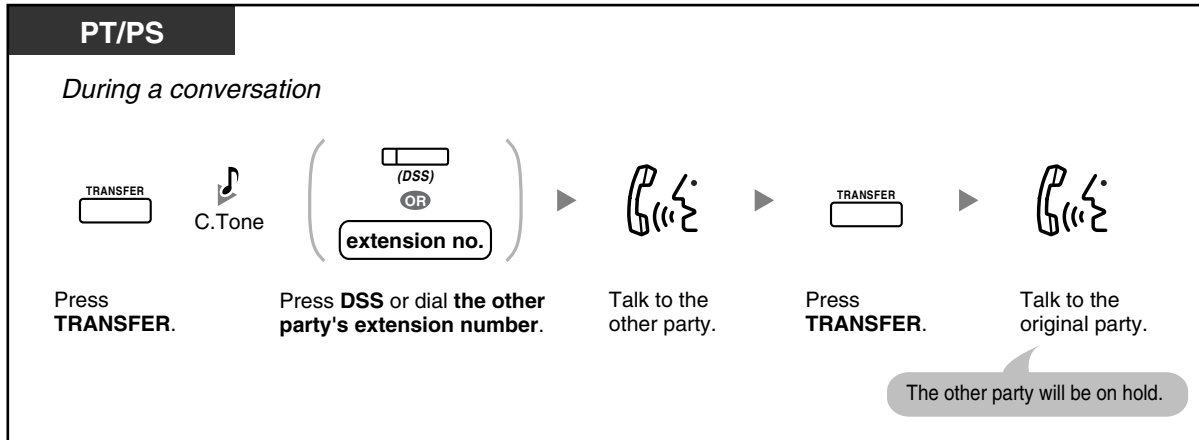

#### To leave the conversation and then let the two parties talk

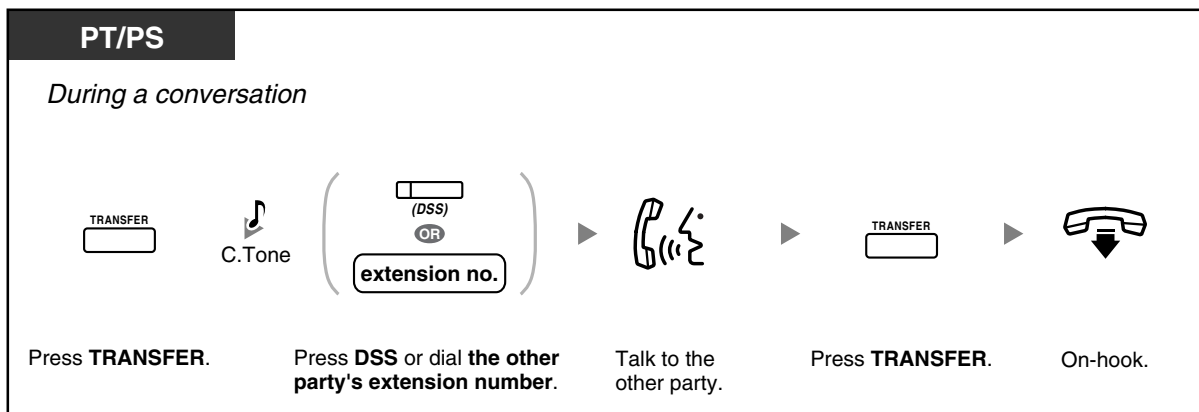

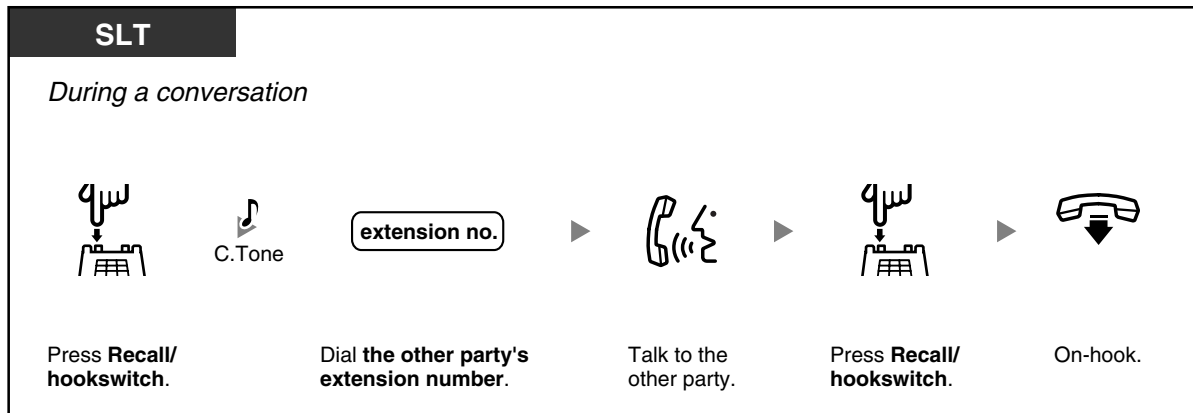

### 1.4.4 Call Waiting

- Answering Call Waiting in the PBX
- Answering Call Waiting from the Telephone Company

#### ◆◆ Answering Call Waiting in the PBX

During a conversation, a call waiting tone or voice announcement through the speaker or the handset occurs when an outside call has been received or another extension is letting you know a call is waiting. You must activate this feature to use it. (Default: Enable—Tone)

**You can answer the second call by disconnecting (1) or holding (2) the current call.**

#### 1. To disconnect the current call and then talk to the new party

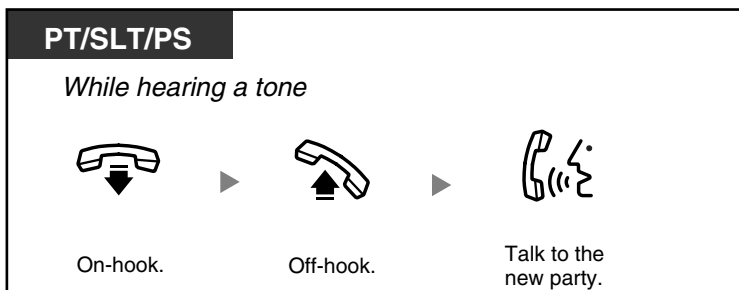



## 2. To hold the current call and then talk to the new party

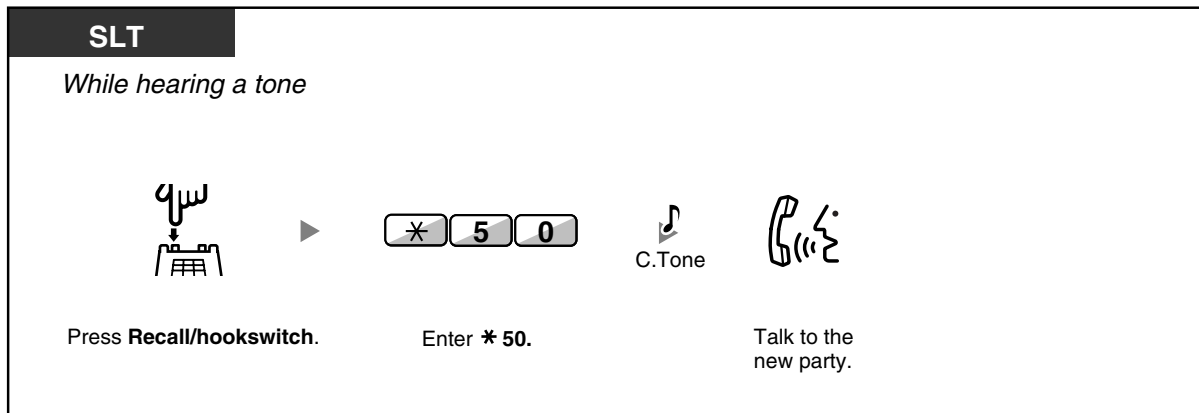
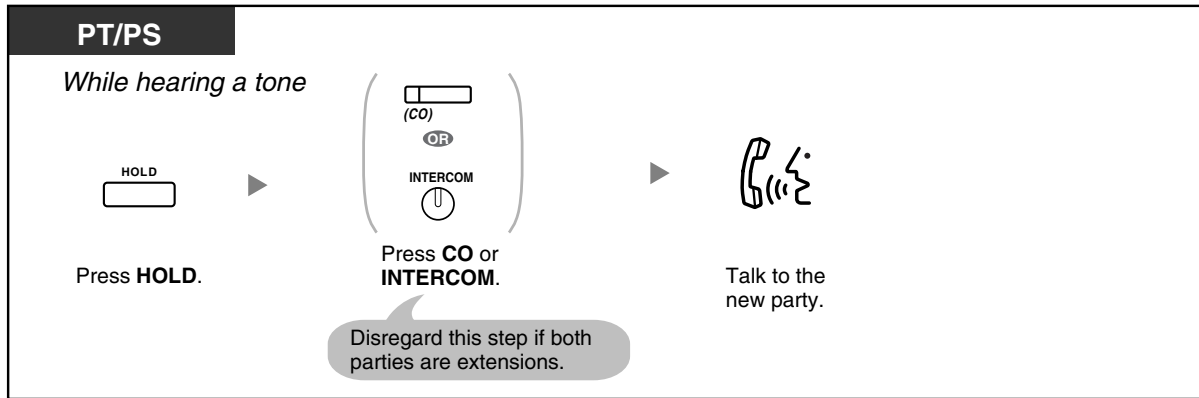

After talking to the new party (second call), you can disconnect (2.1) or hold (2.2) it and then retrieve the first call.

### 2.1 To disconnect the second call and then talk to the original party

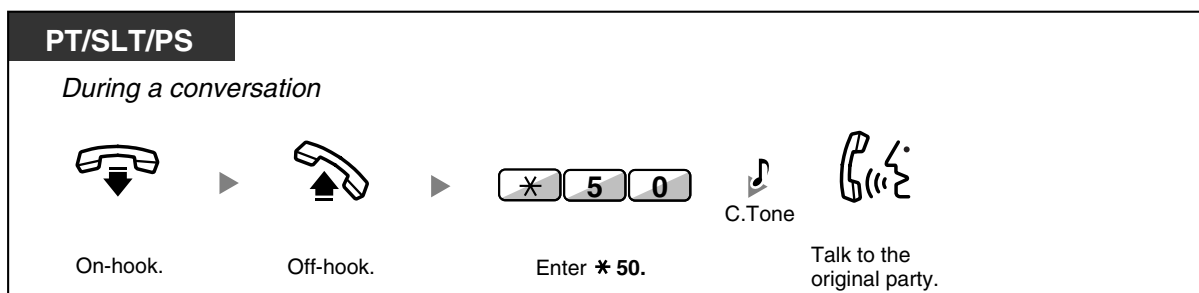
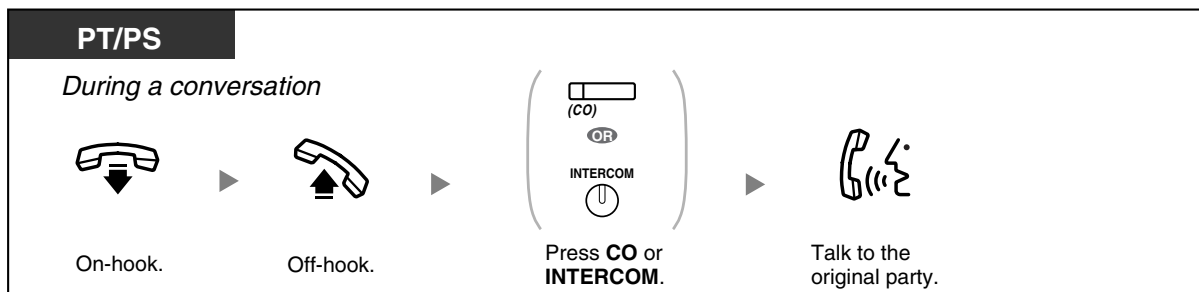

## 2.2 To hold the second call and then talk to the original party

After holding it, you can talk to the original party. Then, you can disconnect it and then talk to the new party again.

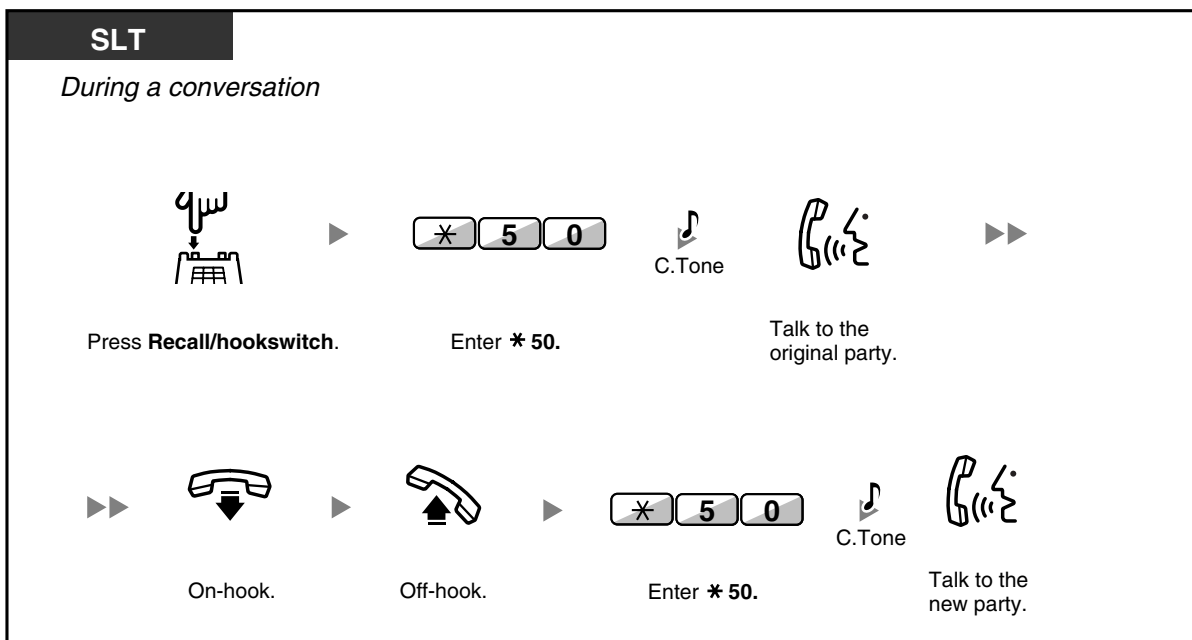
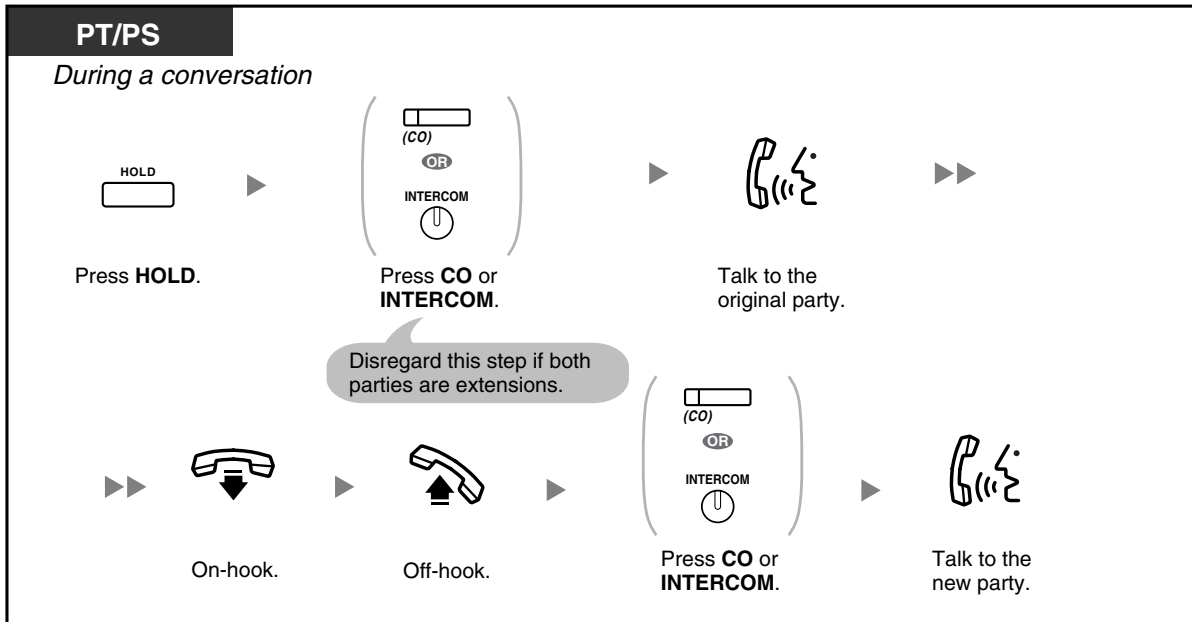

- **Depending on your telephone**, the "Off-hook Call Announcement (OHCA)" and the "Whisper OHCA" features can be used. You can talk to the other party through the speaker and the microphone (OHCA) or you can receive an announcement through the handset (Whisper OHCA), if you are having a conversation using the handset. Refer to "1.7.3 Call Waiting/Off-hook Call Announcement (OHCA)/Whisper OHCA". For telephones capable of using the OHCA and Whisper OHCA features, consult your dealer.
- The caller's name or number is displayed for five seconds in fifteen second intervals while waiting to be answered.



### Customizing Your Phone

- 3.1.2 Settings on the Programming Mode—**Call Waiting Tone Type Selection**  
If you select "Tone 1", you will hear the same tone for Call Waiting from an outside party and an extension. If you select "Tone 2", you will hear different tones for Call Waiting from an outside party and an extension.

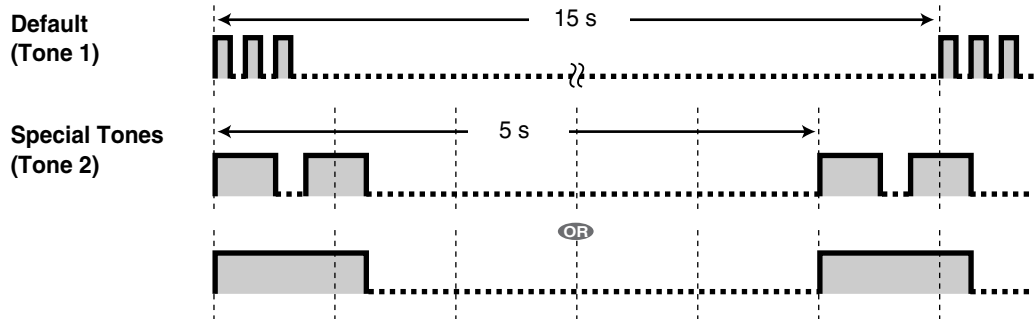

### ◆◆ Answering Call Waiting from the Telephone Company

This is an optional telephone company service. You can receive a call waiting tone with the caller's name or telephone number information. For details, consult your telephone company.

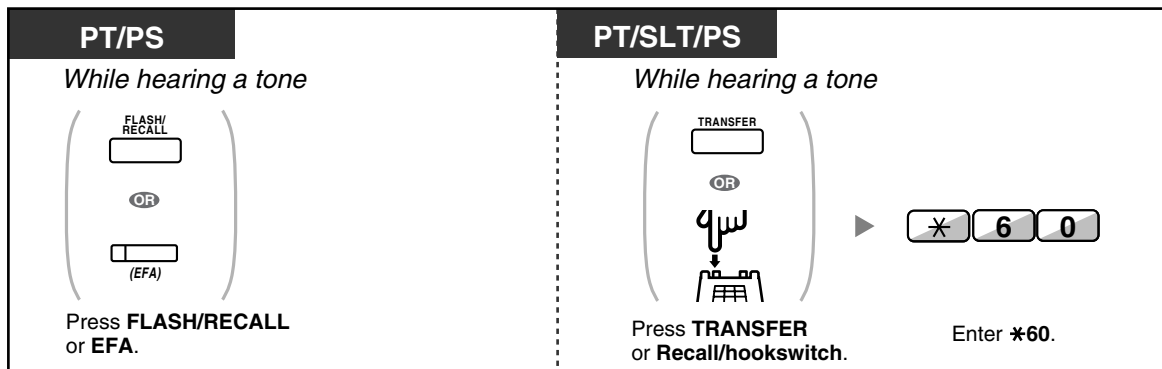

- To return to the original party, repeat the operation.
- In this case, FLASH/RECALL button on proprietary telephones is in the External Feature Access (EFA) mode.
- The caller's telephone number will not be displayed on telephones or wireless phones connected to SLT ports.



### Customizing Your Phone

- 3.1.3 Customizing the Buttons  
Create or edit an External Feature Access (EFA) button.

## 1.4.5 Multiple Party Conversation

- Conference
- Unattended Conference
- Leaving Three-party Conference
- Privacy Release

### ◆◆ Conference

You can add one or more parties to your conversation.

#### To establish a conference call

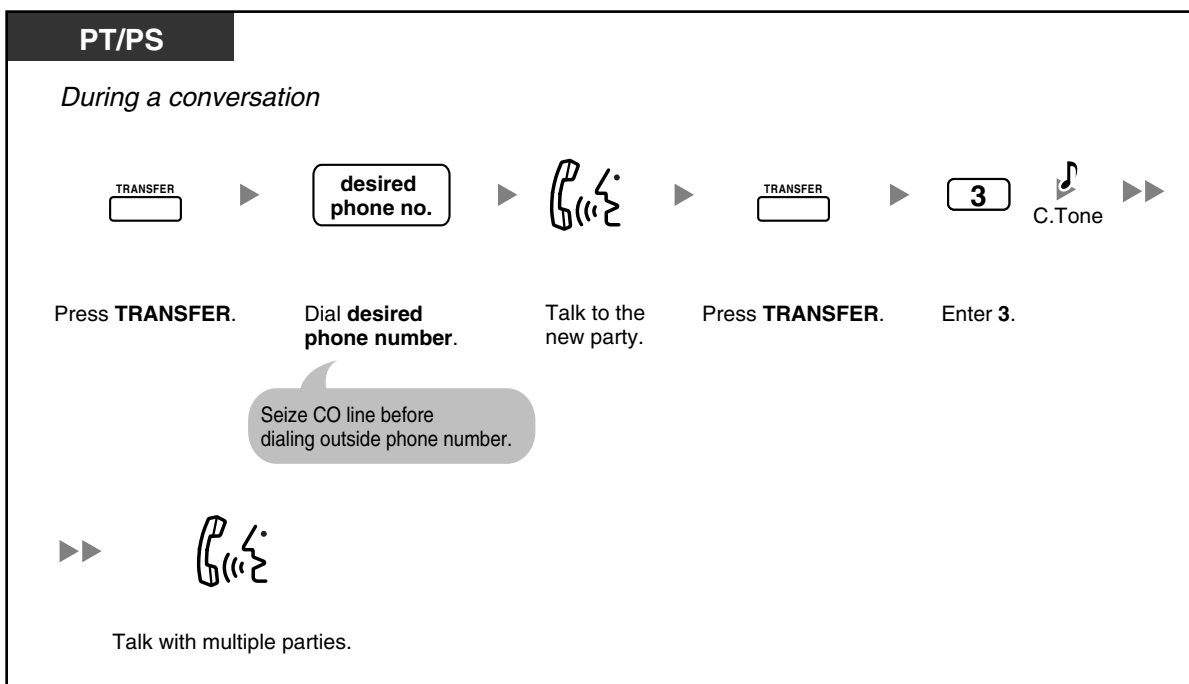
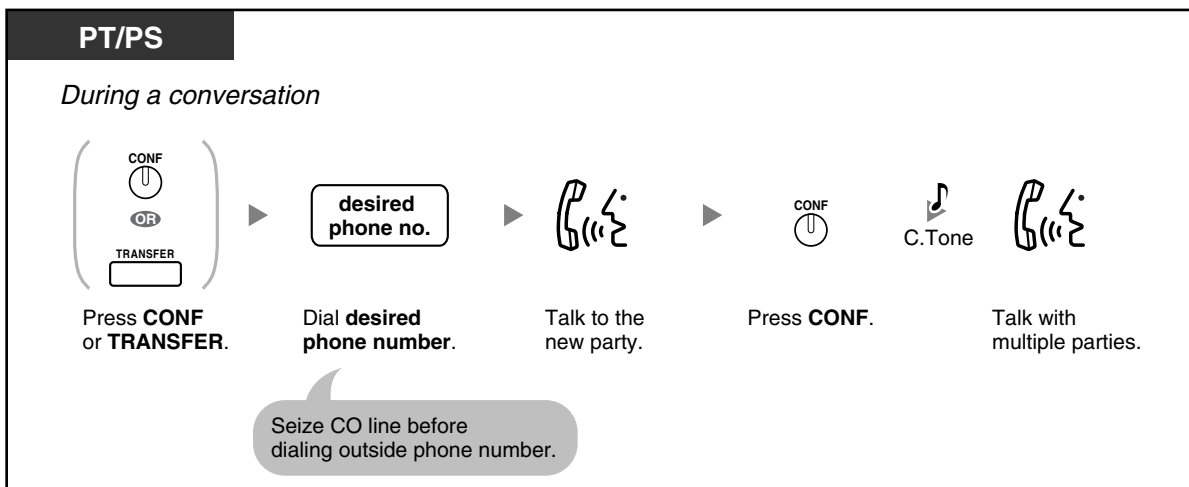

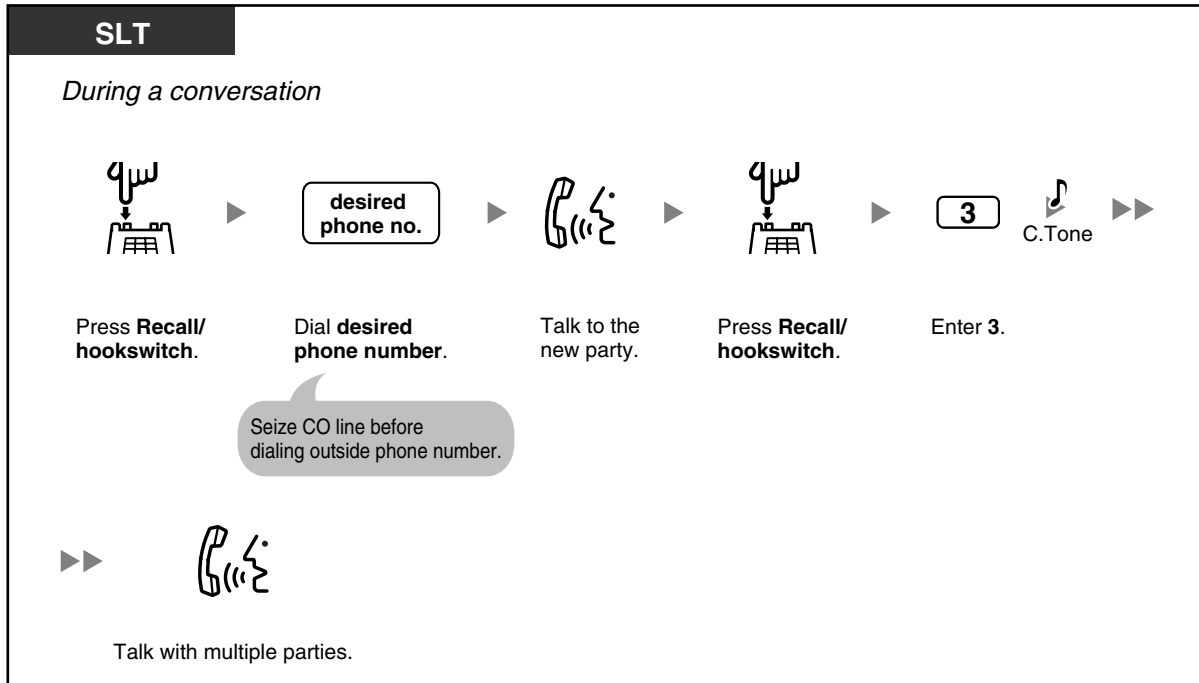

**To establish a conference call when receiving a call from an outside party during a two-party conversation**

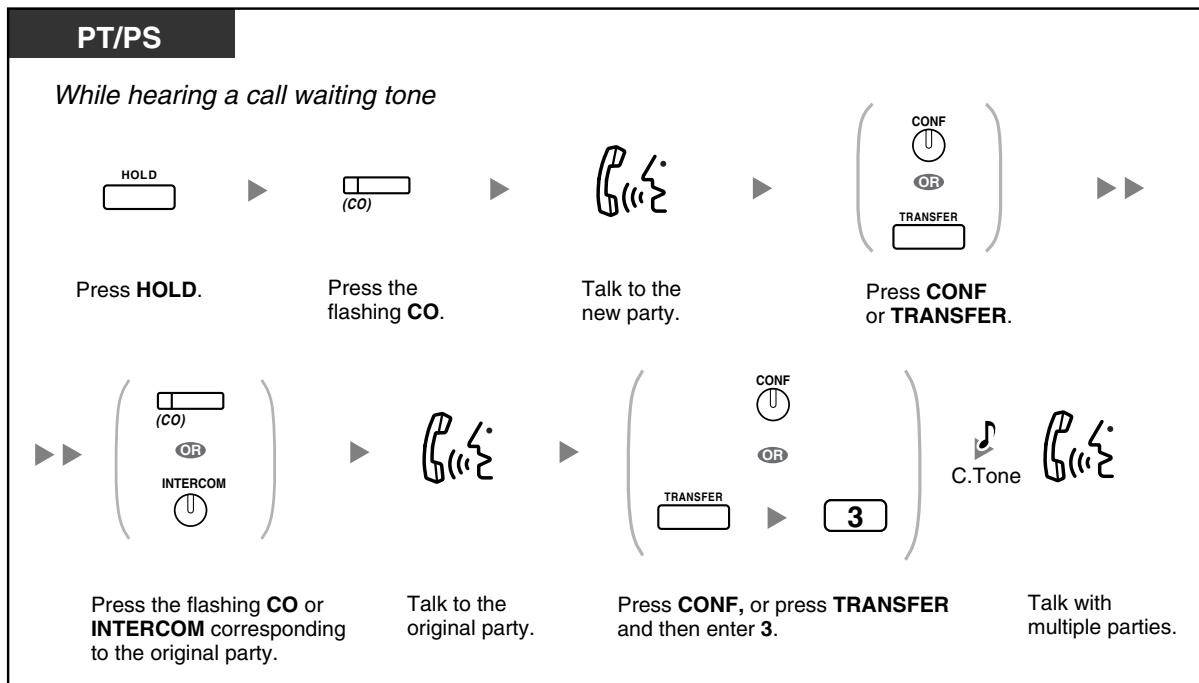

**To add four or more parties to a conference**

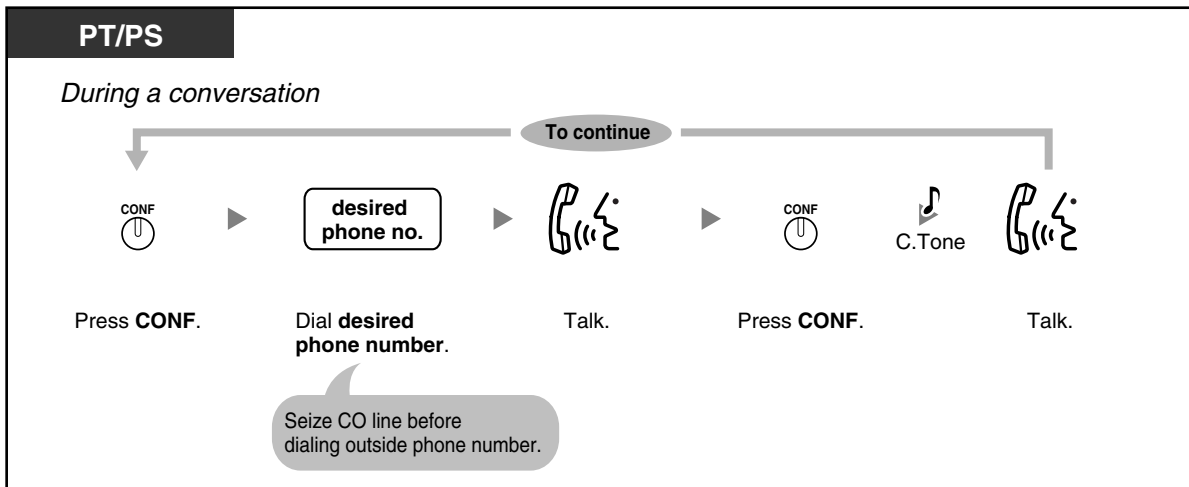

**To add an outside party on hold to a conference**

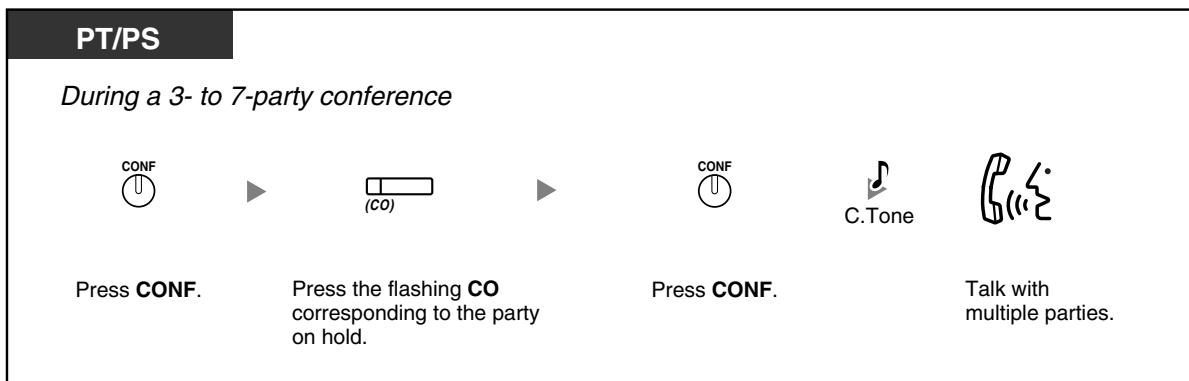

**To talk to two parties alternately in a three-party conversation**

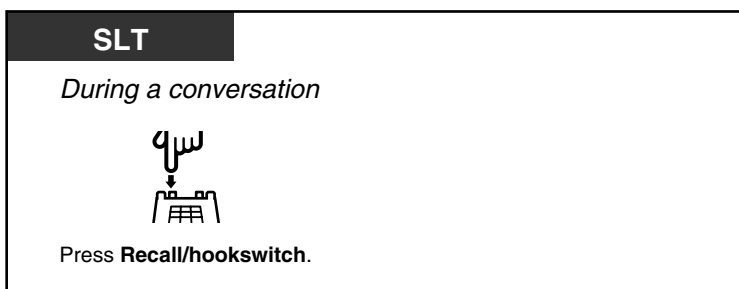
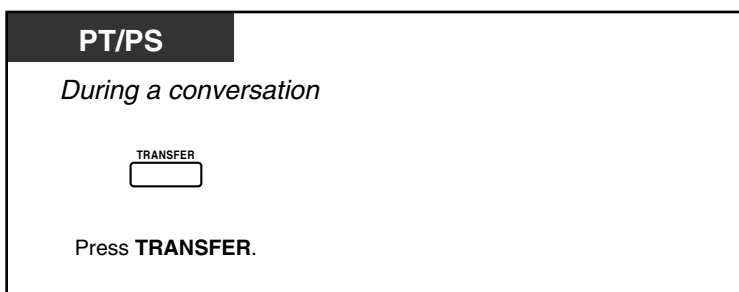

## To disconnect one party and then talk to the other in a three-party conversation

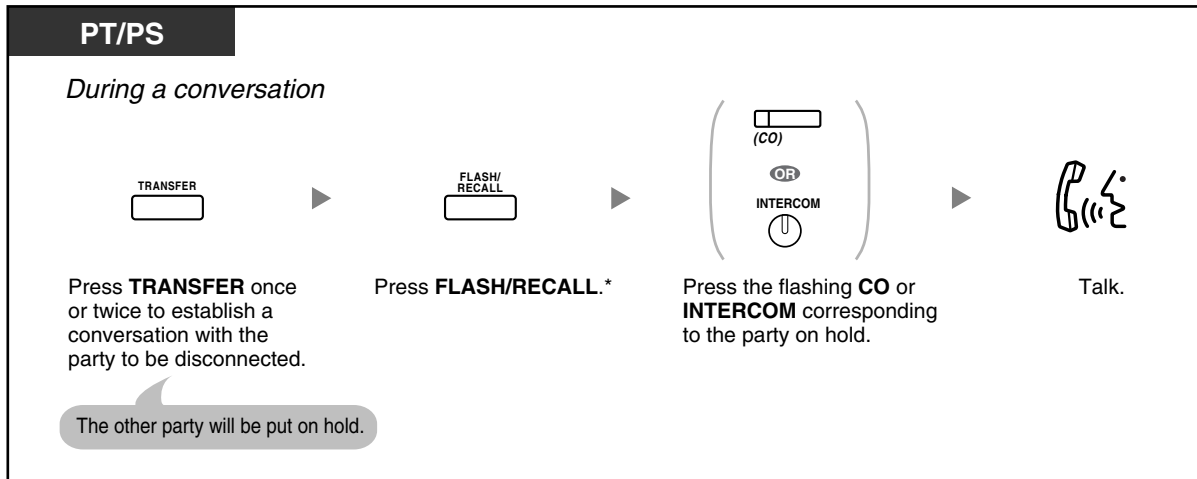

- \* In this case, the FLASH/RECALL button on a proprietary telephone must be in the Flash/Recall mode.
- During a three-party conversation, pressing the TRANSFER button or Recall/hookswitch alternates between the two other parties in the conversation.
- You can have a conference with a maximum of eight parties (comprising intercom or CO lines) simultaneously.
- During a conversation involving four or more parties, you cannot disconnect one party and maintain the conversation with the other parties.



### Customizing Your Phone

- 3.1.3 Customizing the Buttons  
Create or edit a Conference button.



## ◆◆ Unattended Conference

The other parties can continue their conversation.

### To leave a conference

**PT/PS**



*During a 3- to 7-party conference*

Press **CONF**.                      On-hook.

### To return while others are talking

**PT**

   
 (CO)   
    
 

Press flashing green **CO** or **INTERCOM**.

### To complete a conversation

**PT/SLT/PS**

*During a conversation*



On-hook.



- **Time limit**  
Both parties will hear an alarm tone before a specified timeout. The originating extension will hear an alarm tone before timeout. The call is disconnected when the time runs out unless the originating extension returns to the conference.



#### Customizing Your Phone

- 3.1.3 Customizing the Buttons  
Create or edit a Conference button.



## ◆◆ Leaving Three-party Conference

The other two parties can continue their conversation.

### To leave a conference

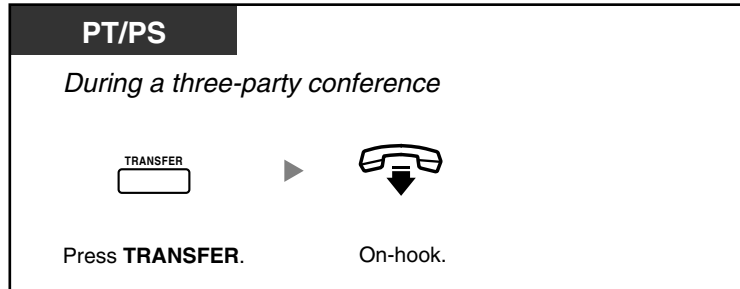

### To complete a conversation



- To leave a conference call involving an outside party or parties and have the conference continue, it is necessary to enable your extension to transfer calls to outside lines through COS programming. Consult your dealer.

## ◆◆ Privacy Release

You can let a third party join your current outside call and establish a three-party conversation. You can also leave the conversation and then let the two other parties talk.



### To let a third party join your conversation and establish a three-party conversation

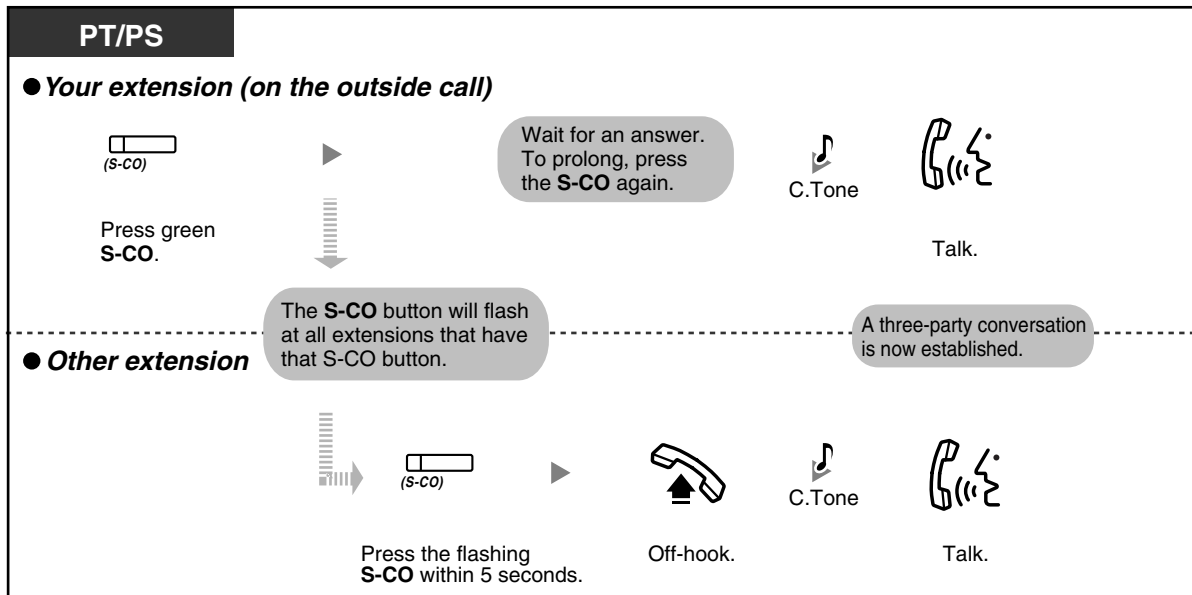

### To leave the conversation and let the two other parties talk

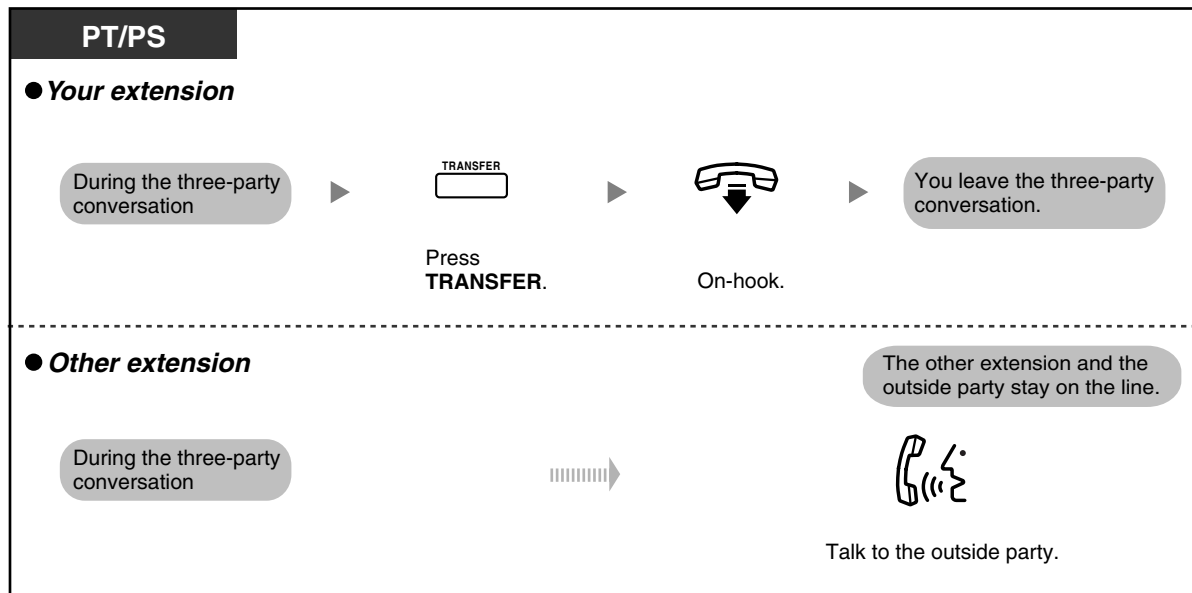

- Only an S-CO button can be used for this operation.
- To leave a three-party conversation and have the conversation continue, it is necessary to enable your extension to transfer calls to outside lines through COS programming. For more details, consult your dealer.

## 1.4.6 Mute

You can disable the microphone or the handset to consult privately with others in the room while listening to the other party on the phone through the speaker or the handset.



### To set/cancel

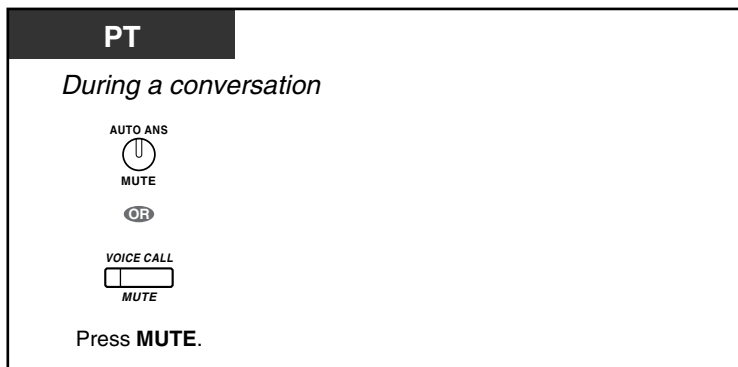

- The AUTO ANS/MUTE or VOICE CALL/MUTE button light shows the current status as follows:
  - Off:** Normal
  - Flashing red:** Mute
- If mute is used during OHCA, it will become Handset Mute.

## 1.4.7 Off-hook Monitor

You can let other people in the room listen to the conversation through the speaker while continuing the conversation using the handset.



### To set/cancel





- The SP-PHONE button light shows the current status as follows:  
**Off:** The voice is heard through the handset.  
**On:** The voice is heard through the speaker and the handset.
- This feature is controlled work by programming. Ask your manager.
- This feature may not be available with certain proprietary telephones. For more details, consult your dealer.



- **Hands-free operation**  
You can have a conversation in hands-free mode using the SP-PHONE button. You can perform other tasks simultaneously.  
**Helpful hints for hands-free operation:**
  - **If it is difficult to hear the other party's voice;**  
Raise the sound level using the Speaker Volume Control.
  - **If the other party has difficulty hearing you;**  
Lower the sound level.
  - **Absorbing echoes;**  
Using this unit in a room which has curtains or carpeting or both.
  - **To avoid missing part of the conversations;**  
If you and the other party speak at the same time, parts of your conversation will be lost. To avoid this, speak alternately.

### 1.4.8 Headset Operation

You can have a conversation using a headset.

In this case, you must select "Headset on" in programming mode or set the Headset button on (red) in advance.

This feature is also known as Handset/Headset Selection.



#### To talk using the headset

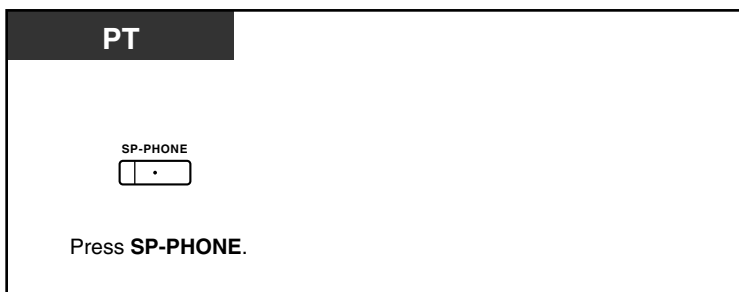

### To use the handset during a conversation using the headset

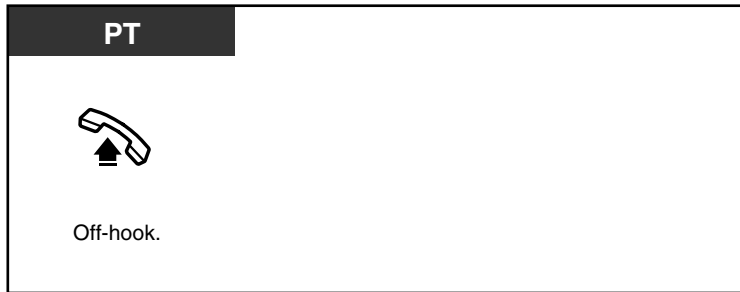

### To talk in hands-free mode during a conversation using the headset



- The Headset button light shows the current status as follows:  
**Off:** Headset mode off  
**Red on:** Headset mode on



#### Customizing Your Phone

- 3.1.2 Settings on the Programming Mode—**Headset Operation**  
 Select the equipment to use.
- 3.1.3 Customizing the Buttons  
 Create or edit a Headset button.

# 1.5 Absence Settings

## 1.5.1 Call Forwarding

- Call Forwarding (FWD)

### ◆◆ Call Forwarding (FWD)

You can have your incoming calls forwarded to a specified destination.

**All Calls:**

All calls are forwarded. Preset extensions may also forward from their own receiving group.

**Busy:**

All calls are forwarded when your extension is busy.

**No Answer:**

All calls are forwarded when you do not answer the call within a specified time period.

**Busy/No Answer (BSY/NA):**

All calls are forwarded when you do not answer within a specified time period or when your extension is busy.

**Follow Me (From):**

If you fail to set the above-mentioned "All Calls" to forward before you leave your desk, you can set the same feature from the destination extension.

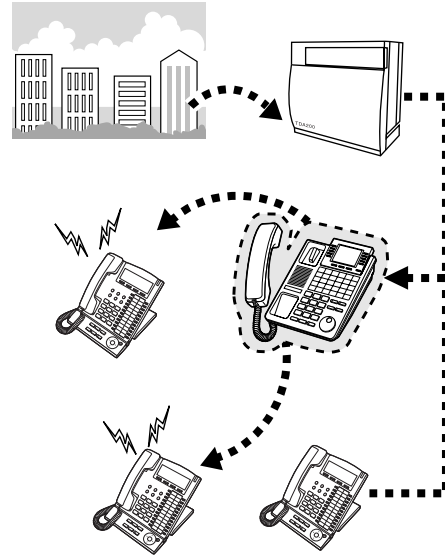

- You can set the voice mail floating extension number as a forward destination to receive calls into your mailbox.
- You can set your mobile telephone as the forward destination. The voice mail can be used to receive calls if you are unable to answer.
- Incoming calls can be forwarded up to four times.
- **Boss & Secretary feature**  
The extension which has been set as the destination can call the forwarding extension.

<Example>

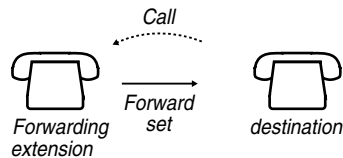

To set/cancel

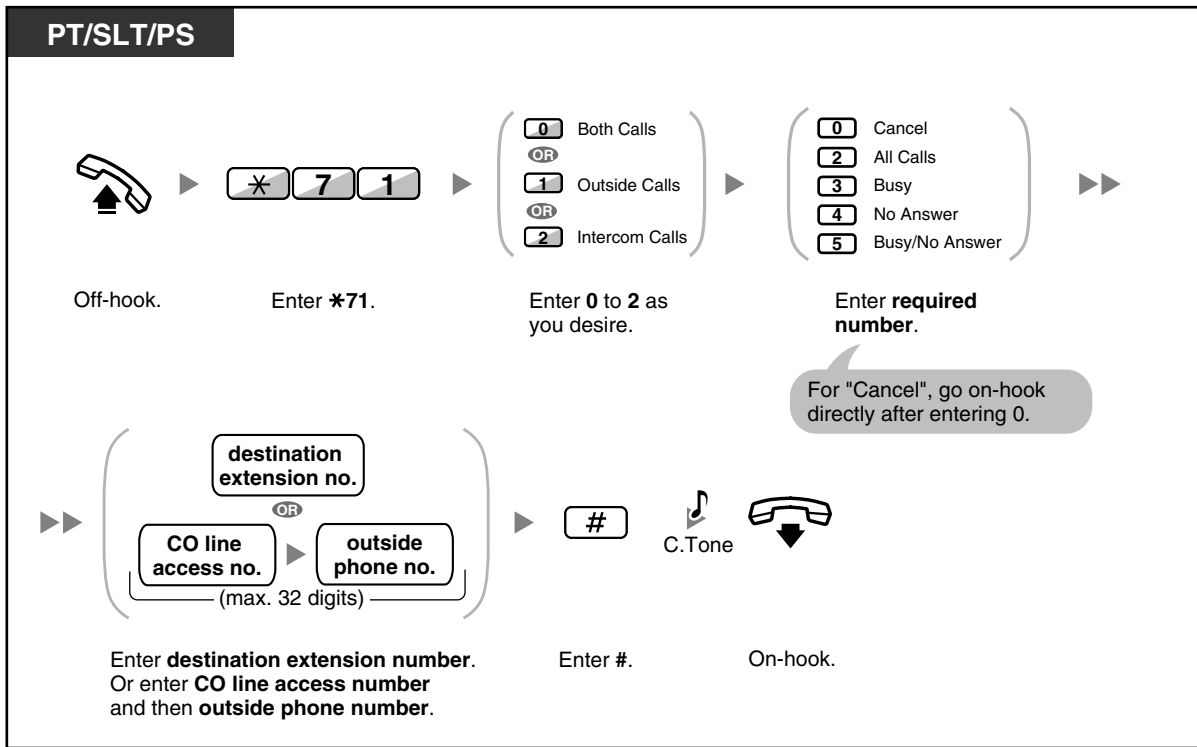

To set from another extension

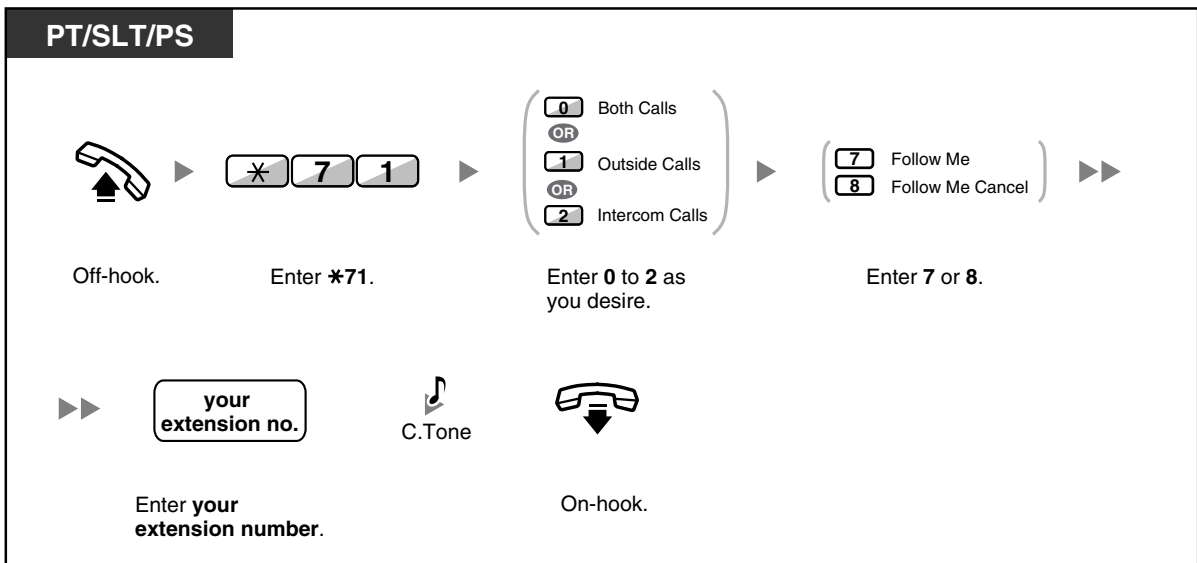

- When using a proprietary telephone, you can set or cancel Call Forwarding by pressing the FWD/DND button (fixed button) instead of "\*710".

### To set the timer for "No Answer" and "Busy/No Answer"

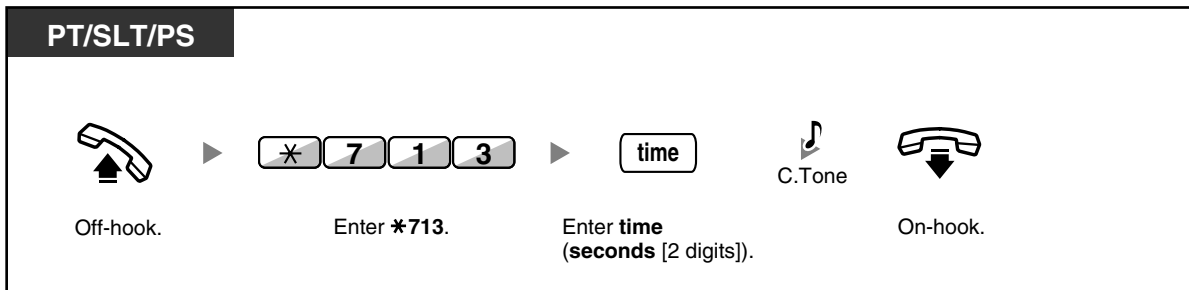

### Call Forwarding (FWD) for your Incoming Call Distribution Group

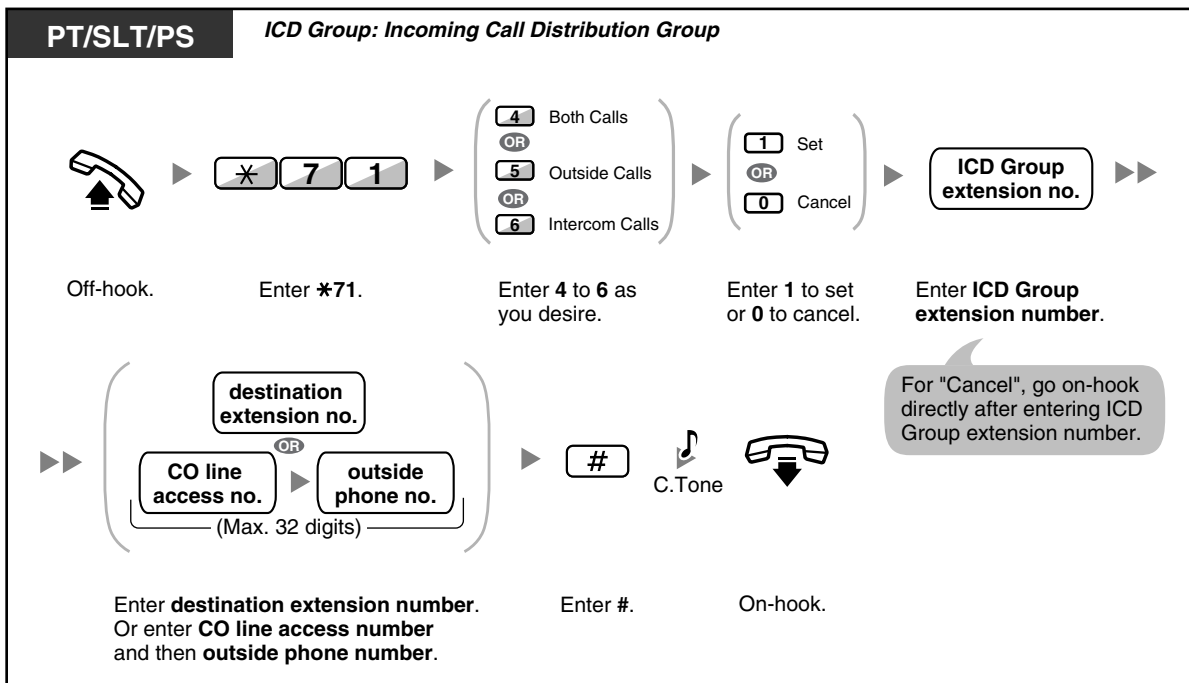

- The FWD/DND button light shows the current status as follows:
  - Off:** Neither feature is set.
  - Flashing red slowly:** FWD mode
  - Red on:** DND mode
- The Group FWD button light shows the current status as follows:
  - Off:** No set
  - Flashing red slowly:** FWD mode



- The system has two modes: (1) FWD/DND Cycle Switch Mode and (2) FWD/DND Setting Mode. Ask your manager what mode your system is in if you are not sure.

**(1) When in the FWD/DND Cycle Switch Mode:**

Pressing the FWD/DND button (fixed button) while in idle status will cycle the setting as shown below:



**(2) When in the FWD/DND Setting Mode:**

Pressing the FWD/DND button (fixed button) while in idle status will take you directly to the programming mode for the FWD/DND setting.  
(Refer to "3.1.2 Settings on the Programming Mode".)

**Note**

A FWD/DND button (customized button) is always in FWD/DND Cycle Switch Mode: the mode cannot be changed.

- Transferred outside calls are also forwarded to the destination assigned for outside calls.
- When intercom calls are set to be handled differently from outside calls (forwarding type, forward destination), we recommend establishing buttons for both FWD/DND—Outside calls and FWD/DND—Intercom calls, and/or Group FWD—Outside calls and Group FWD—Intercom calls, because:
  - the light patterns of the FWD/DND—Both calls button (including FWD/DND button [fixed button]) and the Group FWD—Both calls button will indicate the setting for either outside calls or intercom calls, but not both.

**Note**

The FWD icon on PS display reflects the setting for outside calls only.

- pressing the FWD/DND—Both calls button (including FWD/DND button [fixed button]) or the Group FWD—Both calls button will not change the FWD or DND mode for intercom calls and outside calls separately.



**Customizing Your Phone**

- 3.1.3 Customizing the Buttons  
Create or edit FWD/DND (Both calls, Outside calls, Intercom calls) buttons, or Group FWD (Both calls, Outside calls, Intercom calls) buttons.

## 1.5.2 Absent Message

You can show the reason you do not answer, if the caller uses a Panasonic display proprietary telephone. There are eight preprogrammed messages and one for your personal message (16 characters). The selected message is shown on the display of your telephone.

Message no.	Message (Example)
1	Will Return Soon
2	Gone Home
3	At Ext %%% (Extension number)
4	Back at %:% (Hour:Minute)

## 1.5 Absence Settings

Message no.	Message (Example)
5	Out until %/% (Month/Day)
6	In a Meeting
7	
8	
9	A message assigned for each extension. (Personal Absent Message)

### To set

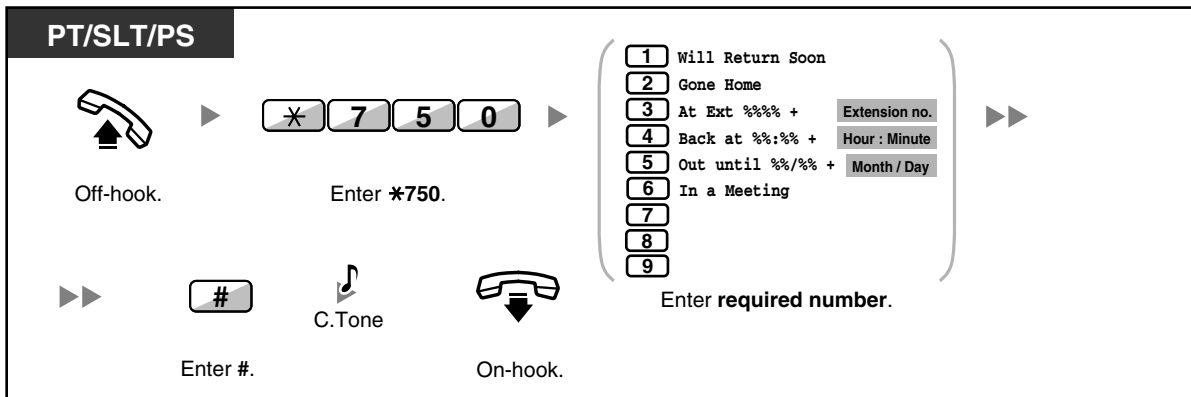

### To cancel

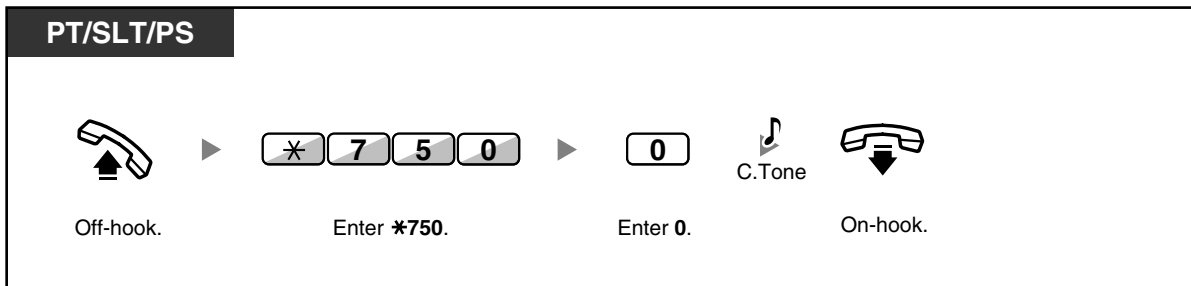

- Enter the desired value in the "%" positions. You must enter the correct number of characters as represented by the "%" using 0 to 9 or \*.
- The default messages can be changed. Consult your dealer.
- To create your personal message (Message no. 9), refer to "3.1.2 Settings on the Programming Mode".

## 1.5.3 Extension Lock

You can lock your extension so that other users cannot make inappropriate outside calls. This feature is also known as Electronic Station Lockout.

### To lock

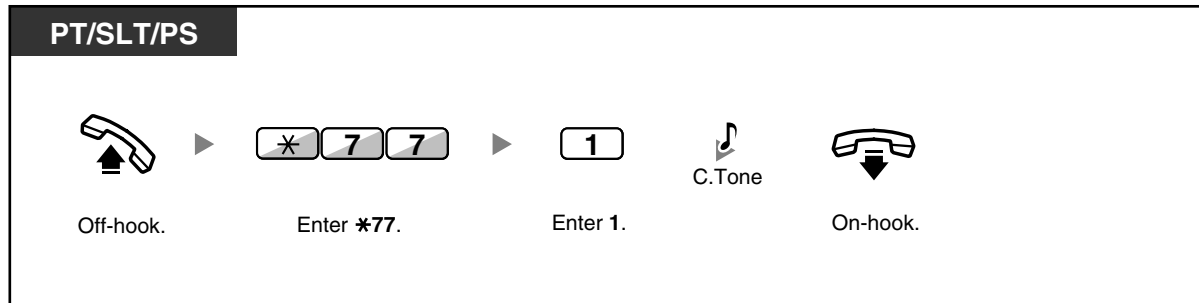

### To unlock

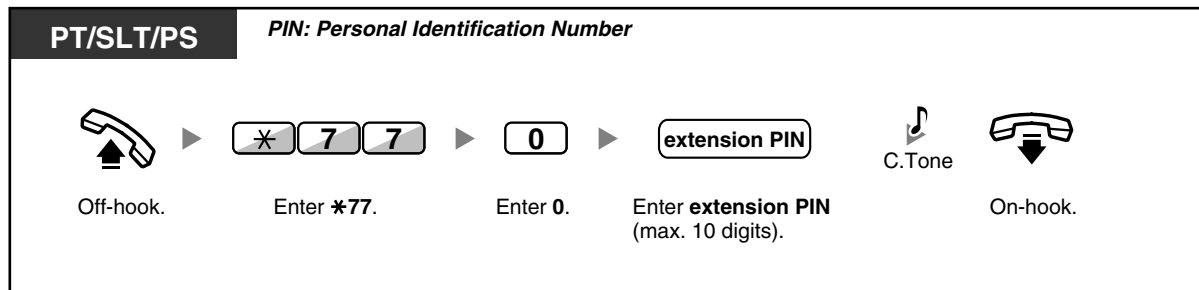

- **If you forget the extension PIN or cannot unlock your phone**, consult your manager. He can clear your extension PIN. Then, you can set the new PIN and unlock your extension by entering it.
- If your extension is locked by this feature, it cannot perform the following operations:
  - Making outside calls
  - Changing the call forwarding destination
- If you do not set extension PIN, you cannot lock and unlock.

# 1.6 Paging

## 1.6.1 Paging

- Group Paging
- Paging and then Transferring a Call

### ◆◆ Group Paging

You can make a voice announcement to proprietary telephones or external speakers or both in the preset group simultaneously.

#### To page

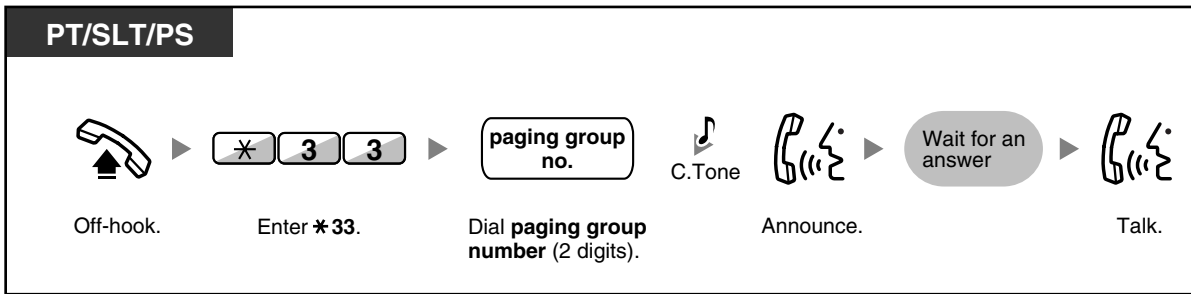

- If the group which you paged is already being used for paging, you hear a busy tone.

### ◆◆ Paging and then Transferring a Call

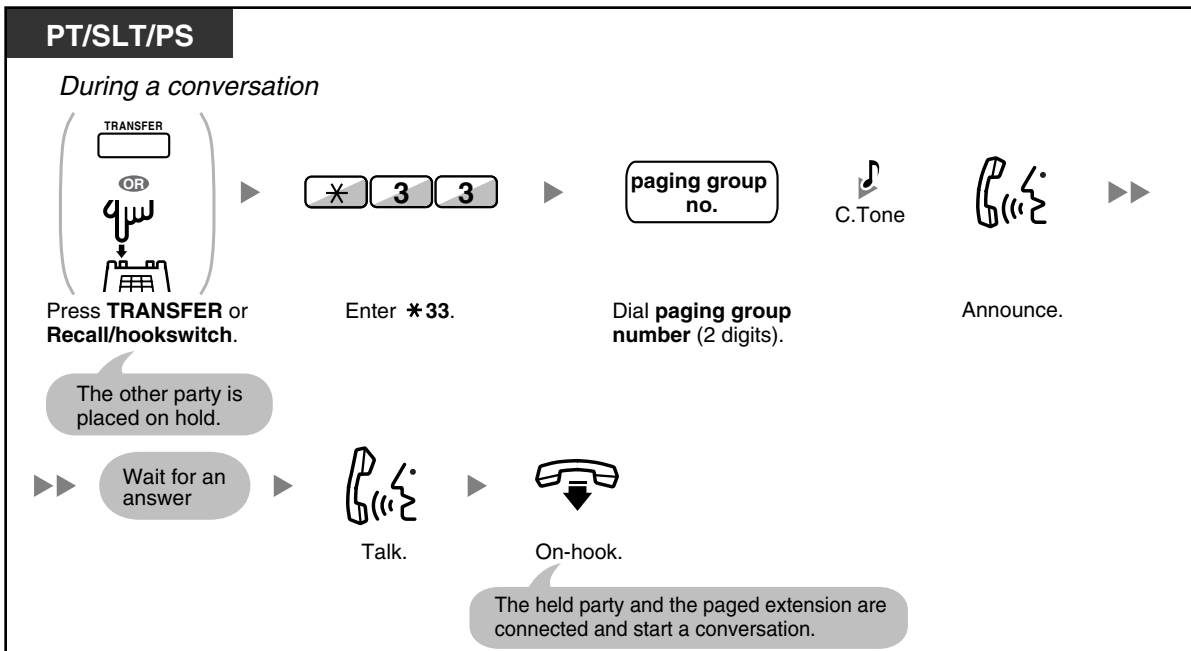



- After you go on-hook, the caller can talk to the person who answers the page.

## 1.6.2 Answering/Denying a Paging Announcement

To answer

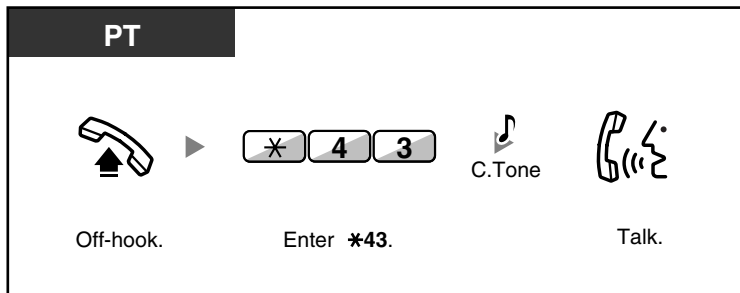

Paging Deny

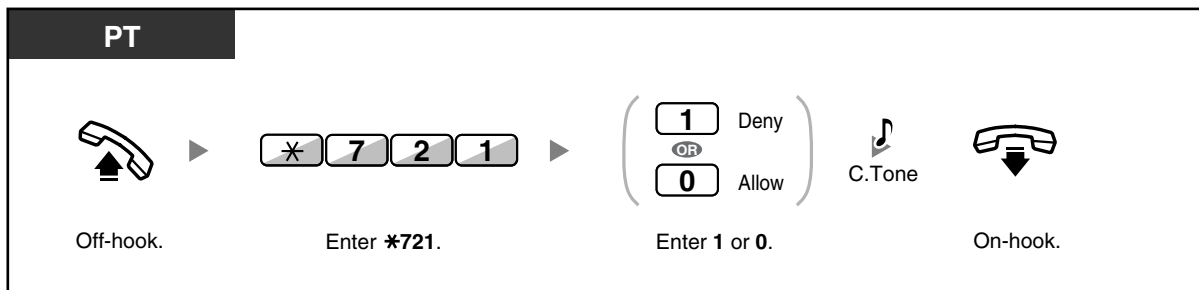

- The following are extensions that cannot receive a paging announcement:
  - Portable station
  - Single line telephone
  - Proprietary telephone that is ringing or busy
  - Proprietary telephone in Paging Deny mode
  - Proprietary telephone in DND mode
- Even if the announcement is not paging your extension, you can answer it, if it is paging your group.

# 1.7 Extension Settings

## 1.7.1 Timed Reminder

You can receive an alarm at your telephone to remind you of a meeting, appointment or as a wake-up call. The alarm can occur either once or daily (every day until canceled) at a preset time. When you go off-hook to answer, you will hear a special dial tone or prerecorded message.

### To set

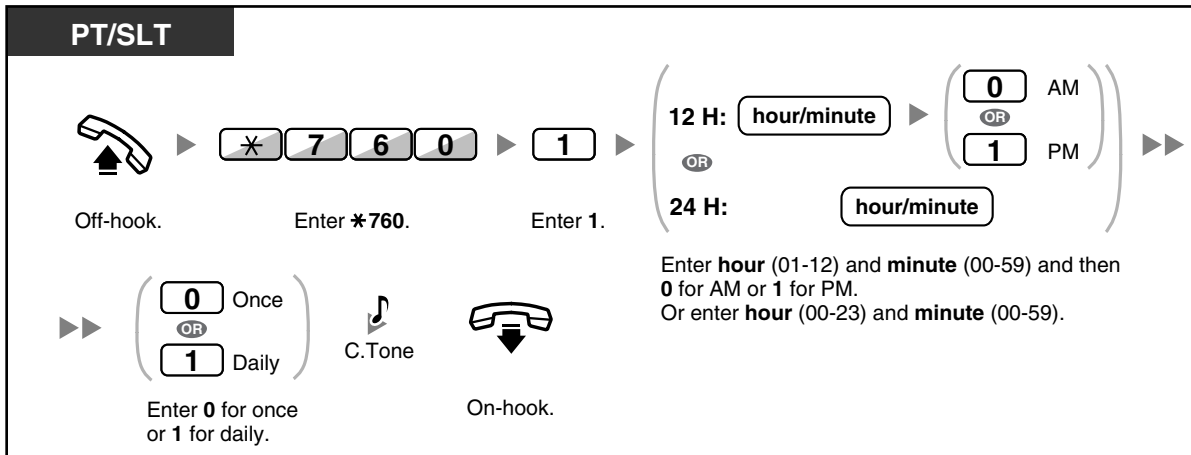

### To cancel

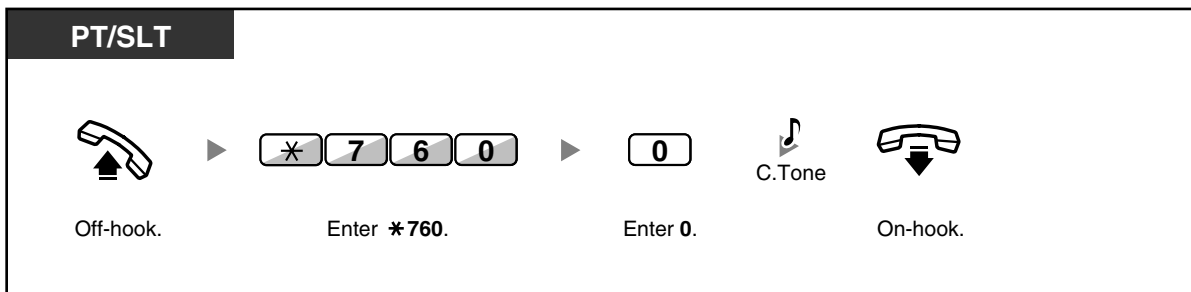

### To stop or answer the ringback

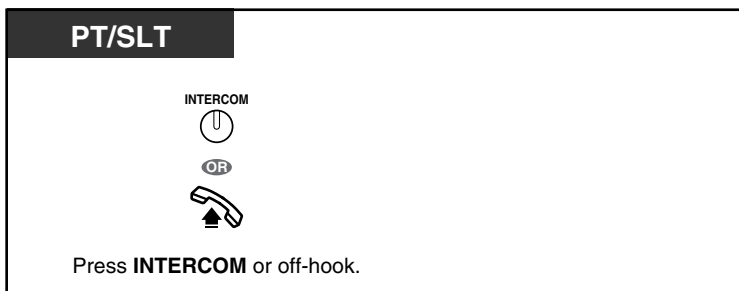

**To confirm**

- You can also confirm the Timed Reminder by using the soft button.
- The alarm keeps ringing for preprogrammed seconds.
- **If you receive an incoming call during ringback**, the ringing starts after the ringback stops.
- **If you are having a conversation exceeding alarm ringing period**, the ringback will start after your conversation.

**1.7.2 Do Not Disturb (DND)**

You may set this feature when you are in a meeting or busy.

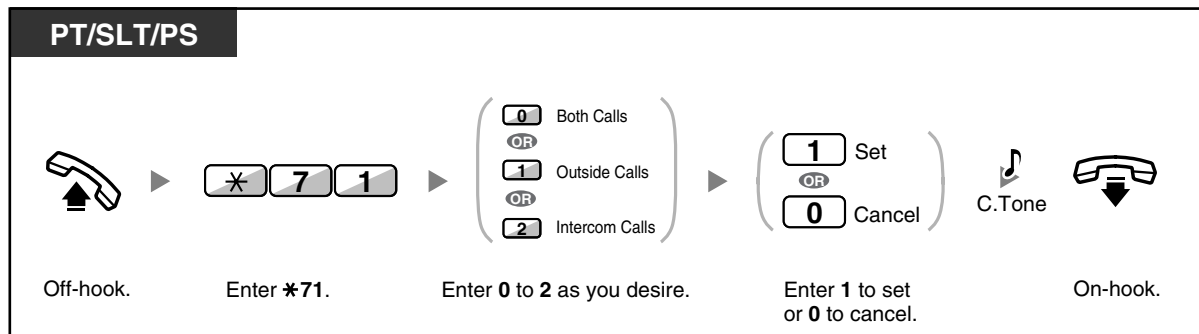
**To set/cancel**

- When using a proprietary telephone, you can set or cancel Do Not Disturb by pressing the FWD/DND button (fixed button) instead of "\*710".



- The FWD/DND button light shows the current status as follows:  
**Off:** Neither feature is set.  
**Flashing red slowly:** FWD mode  
**Red on:** DND mode
- The system has two modes: (1) FWD/DND Cycle Switch Mode and (2) FWD/DND Setting Mode. Ask your manager what mode your system is in if you are not sure.

**(1) When in the FWD/DND Cycle Switch Mode:**

Pressing the FWD/DND button (fixed button) while in idle status will cycle the setting as shown below:



**(2) When in the FWD/DND Setting Mode:**

Pressing the FWD/DND button (fixed button) while in idle status will take you directly to the programming mode for the FWD/DND setting. (Refer to "3.1.2 Settings on the Programming Mode".)

**Note**

A FWD/DND button (customized button) is always in FWD/DND Cycle Switch Mode: the mode cannot be changed.

- If your extension has set this feature, a calling extension will hear DND tone.
- If this feature is set, the Call Forwarding (FWD) feature does not work.
- Specified extensions can override this feature and call DND extensions (DND Override).
- When intercom calls are set to be handled differently from outside calls (DND set/cancel), we recommend establishing buttons for both FWD/DND—Outside calls and FWD/DND—Intercom calls, because:
  - a) the light patterns of the FWD/DND—Both calls button (including FWD/DND button [fixed button]) will indicate the setting for either outside calls or intercoms calls, but not both.

**Note**

The DND icon on PS display reflects the setting for outside calls only.

- b) pressing the FWD/DND—Both calls button (including FWD/DND button [fixed button]) will not change the FWD or DND mode for intercom calls and outside calls separately.



### Customizing Your Phone

- 3.1.3 Customizing the Buttons  
Create or edit FWD/DND (Both calls, Outside calls, Intercom calls) buttons.



## 1.7.3 Call Waiting/Off-hook Call Announcement (OHCA)/Whisper OHCA

During a conversation, you can be informed of a call waiting with a tone or voice announcement through your built-in speaker or handset. (Default: Enable—Tone)

### Call Waiting Tone:

a waiting tone through the built-in speaker of PT/handset of SLT. To change the tone from PT, refer to "3.1.2 Settings on the Programming Mode".

### OHCA:

a voice announcement through the built-in speaker

### Whisper OHCA:

a voice announcement through the handset

### To set/cancel for intercom calls

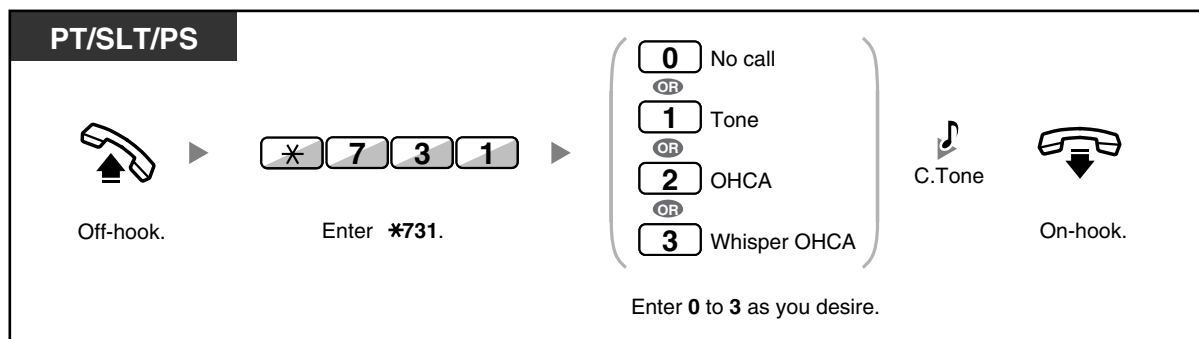

### To set/cancel for outside calls

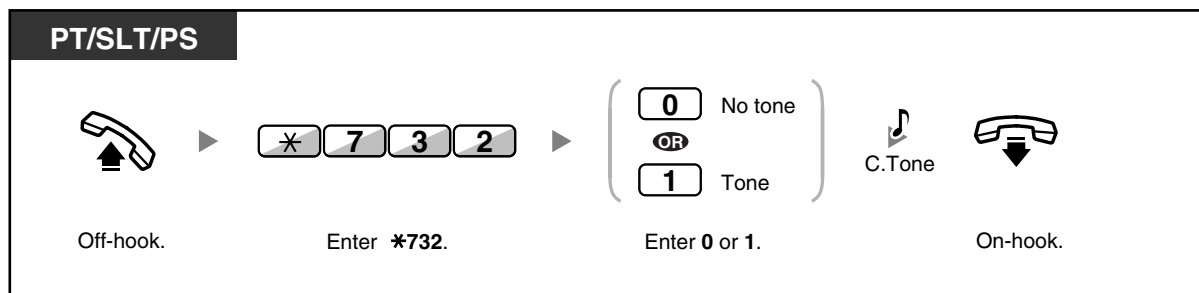

- OHCA is only available with certain digital proprietary telephones. For more details, consult your dealer.
- Whisper OHCA is only available with certain digital proprietary telephones and IP proprietary telephones. In addition, both you and the other party must use supported telephones. For more details, consult your dealer.

## 1.7.4 Calling Line Identification Presentation (CLIP)

**CLIP:**

When making an outside call, you can present your preprogrammed telephone number to the called party.

You can select the telephone number sent, either the number of the line used or the number assigned to your extension.

If you select "Public", the calling/called party sees the number of the line used (subscriber's number).

If you select "Your extension", they see the telephone number assigned on your extension.

**To show either the number assigned to the CO line or your extension**

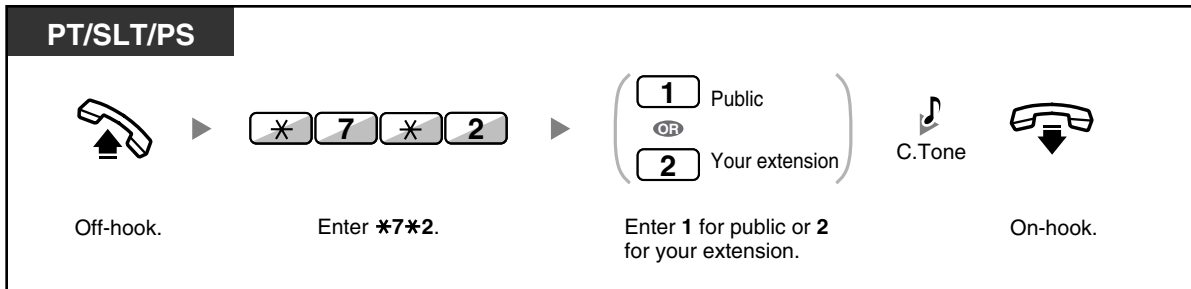

- If you use the G-DN button to make a call to the other party, the telephone number assigned to the G-DN will be used.

## 1.7.5 Calling Line Identification Restriction (CLIR)

When making an outside call, you can select whether the called party can see your telephone number or not.

**To show/prevent**

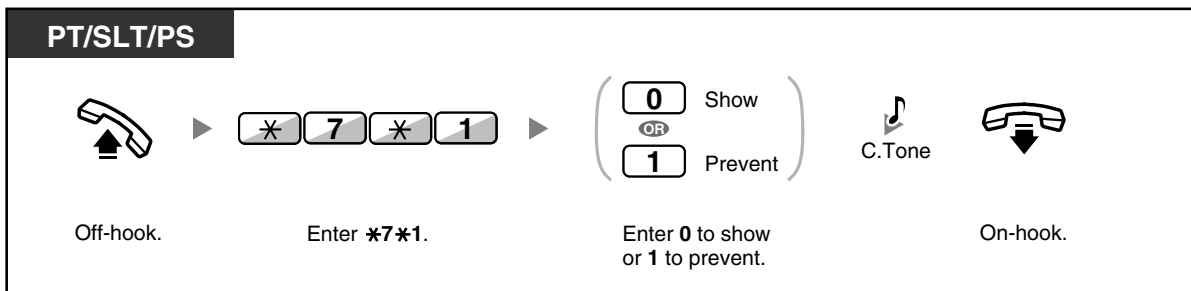

- You can change the mode by pressing a preset CLIR button while on-hook. The CLIR button light shows the current status as follows:  
**Off:** shows your telephone number.  
**Red on:** prevents your telephone number being displayed.
- Availability of this feature depends on the ISDN service of your telephone company.



**Customizing Your Phone**

- 3.1.3 Customizing the Buttons  
 Create or edit a Calling Line Identification Restriction (CLIR) button.

## 1.7.6 Executive Busy Override Deny

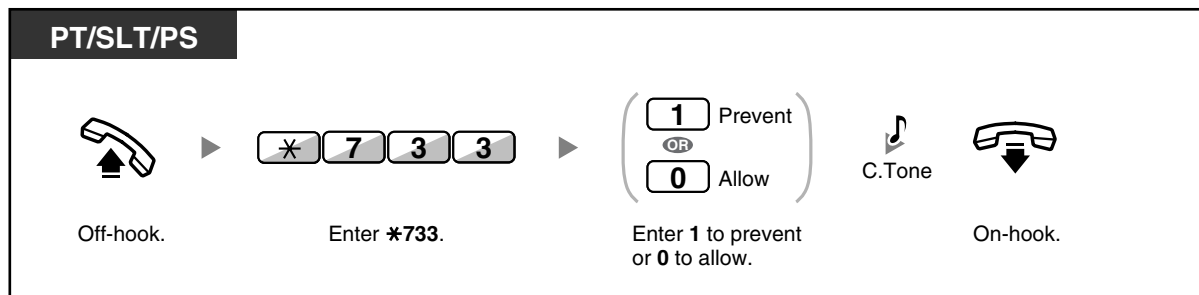

- Some extensions may be prohibited from performing this feature.

## 1.7.7 Background Music (BGM)

You can listen to the background music through your telephone speaker while on-hook. An external music source, such as a radio, must be connected. If your extension becomes busy (off-hook, making or receiving a call etc.), the music stops temporarily. When you go back on-hook, the music starts again.



### To select and set/cancel

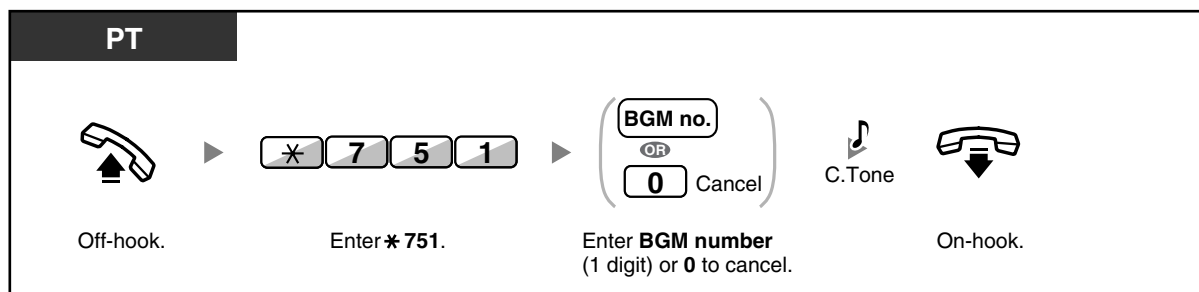

## 1.7.8 Data Line Security

You can protect the line against audible notification tones, such as a call waiting tone during a conversation. Set this feature if your extension has a data communication device, such as a computer or fax machine connected to ensure secure data transmission.

### To set/cancel

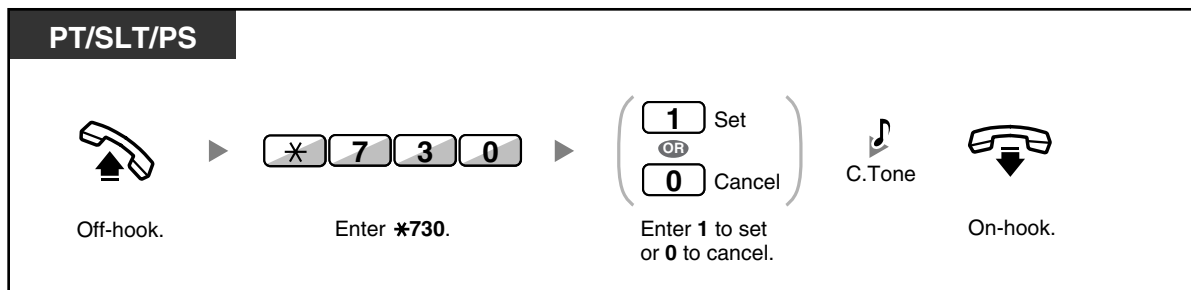

## 1.7.9 Time Service

You can check the current status of the Time Service on the display.

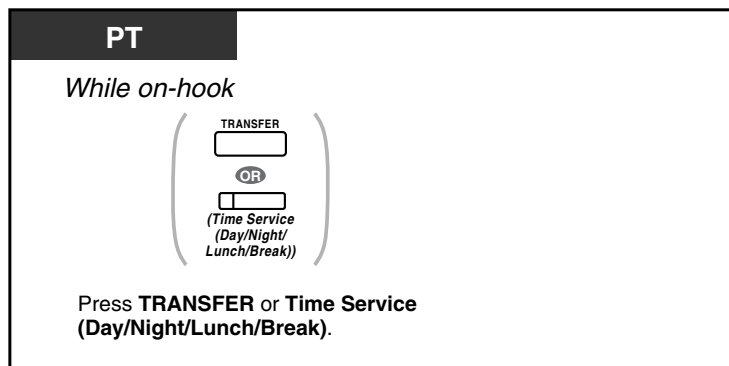

- The Time Service (Day/Night/Lunch/Break) button light always shows the current status as follows:
  - Off:** Day mode
  - Green on:** Lunch mode
  - Flashing green:** Break mode
  - Red on:** Night mode
  - Flashing red:** Holiday mode
- Any extension user except the managers can check the current status by pressing the Time Service (Day/Night/Lunch/Break) button.



### Customizing Your Phone

- 3.1.3 Customizing the Buttons
  - Create or edit a Time Service (Day/Night/Lunch/Break) button.

## 1.7.10 Paralleled Telephone

A digital proprietary telephone extension user can choose whether the single line telephone connected in parallel will ring or not, when an incoming call is received. (Default: Ring)

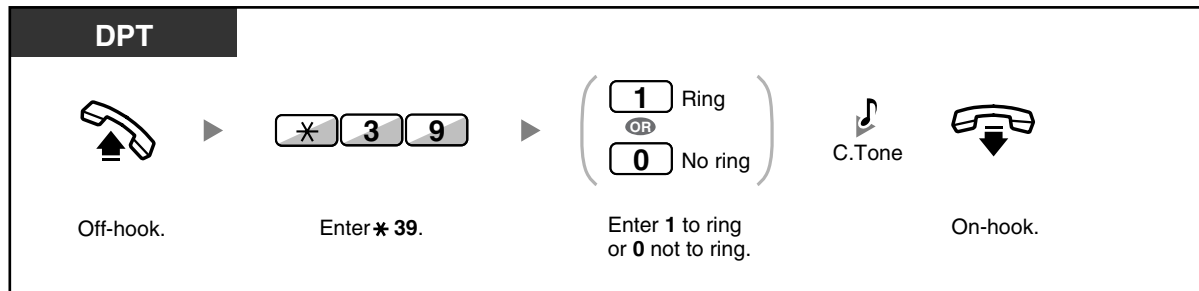

- **Even if "No ring" is selected**, calls can be made and answered on the single line telephone by lifting the handset.
- **If you go off-hook while your paralleled telephone is in use**, the call will switch over to you.

## 1.7.11 Wireless XDP Parallel Mode

Your PS can be used in parallel with a PT or SLT. When in this mode, incoming calls to a wired telephone also ring the paired PS.

### To set

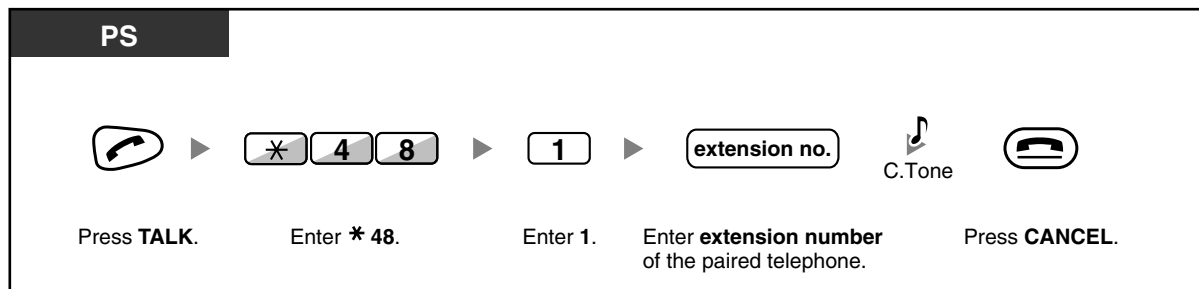

### To cancel

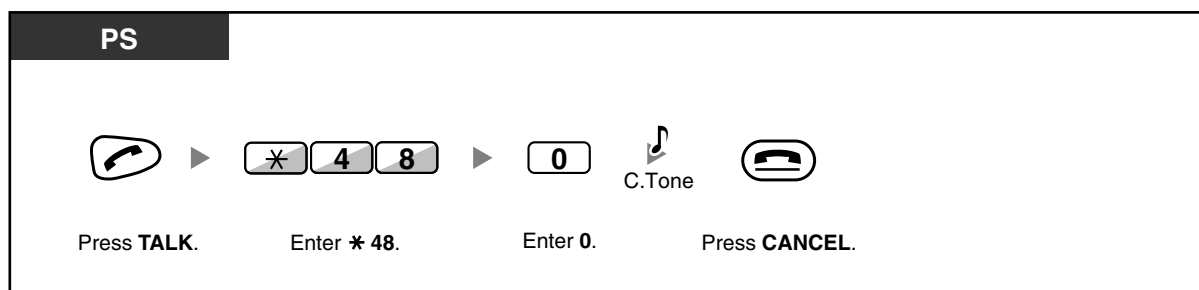



- Some wired telephones are prohibited from using this feature.
- **If you go off-hook while your paralleled telephone is in use**, the call will switch over to you.

## 1.7.12 Extension Feature Clear

You can reset the settings of the following features on your extension to the default settings with one operation.

This feature is also known as Station Program Clear.

Features	Default Setting
Hot Line*	Off
Message Waiting—(All the messages that have been left by other extension users)	Off
Call Pickup Deny	Allow
Call Forwarding (FWD)*	Off
Absent Message	Off
Paging Deny	Allow
Timed Reminder	Cleared
Do Not Disturb (DND)*	Off
Call Waiting*	Enable—Tone
Executive Busy Override Deny	Allow
BGM	Off
Data Line Security	Off
Paralleled Telephone	The telephone in parallel rings.
Log-in/Log-out	Log-in

\* These features may not be reset depending on the system programming.

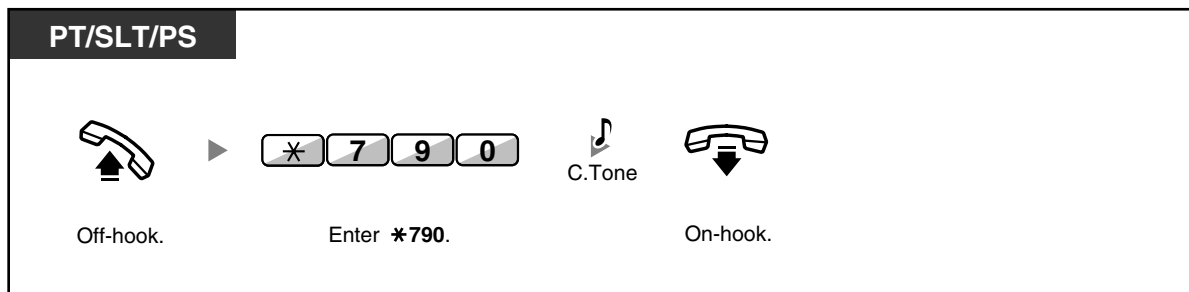

- After performing Extension Feature Clear, the setting of Call Waiting becomes "Enable—Tone". In this case, dial tone 2 will be heard when you go off-hook.

# 1.8 Call Center

## 1.8.1 Log-in/Log-out, Wrap-up

You can control your status in an incoming call distribution group. When in the Log-out mode, incoming calls to the group will not ring at your extension. When you return, calls will again ring at your extension. (Default: Log-in)  
 Even if your extension is logged-in, you can have a specified time period (wrap-up time) when you will not receive calls after completing a previous call. This time can be used for you to write a report and so on.  
 You can also manually select "Not Ready" mode to temporarily leave a distribution group.

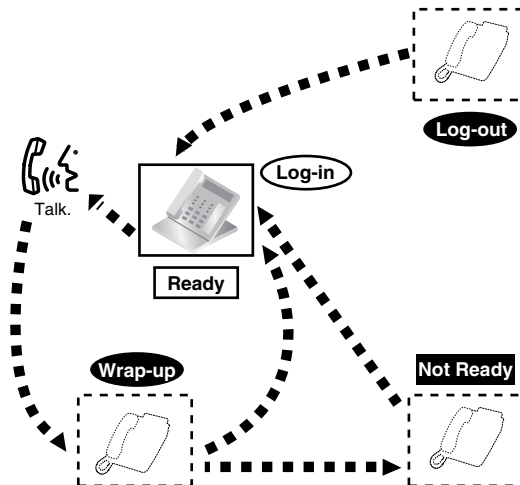

### To set Log-in/Log-out

**PT/SLT/PS**      *ICD Group: Incoming Call Distribution Group*

  
 Off-hook.

  
 Enter \*736.

0 Log-out  
 OR  
 1 Log-in

  
 Enter 0 or 1.

ICD Group extension no. Specified  
 OR  
 \* All

  
 Enter ICD Group extension number or \*.

  
 C.Tone

  
 On-hook.

**PT/PS** *ICD Group: Incoming Call Distribution Group*

*While on-hook*

Press **Log-in/Log-out**. Enter ICD Group extension number or \*.

**PT/PS**

*While on-hook*

Press **Log-in/Log-out of a Specified Group**.

**To enter/leave the Not Ready mode**

**PT/SLT/PS**

Off-hook. Enter \*735. Enter 1 or 0. C.Tone On-hook.

**To set/cancel the Not Ready mode or to leave the Wrap-up mode (To enter the Ready mode)**

**PT/PS**

*While on-hook*

Press red or flashing red **Wrap-up**.\*





- \* The status will be as follows:  
 Ready → Not Ready  
 Not Ready → Ready  
 Wrap-up → Not Ready
- The Log-in/Log-out of a specified group button light shows the current status as follows:  
**Off:** Log-in mode  
**Red on:** Log-out mode
- The Wrap-up button alternates the setting of Wrap-up mode, Not Ready mode or Ready mode.  
 The Wrap-up button light shows the current status as follows:  
**Off:** Ready mode  
**Red on:** Not Ready mode  
**Flashing red:** Wrap-up mode
- In Wrap-up mode/Not Ready mode, your extension does not receive calls through any group, even if it belongs to multiple groups.
- There may be at least one extension in the incoming call distribution group that is in the Log-in mode.
- The Supervisor extension can control the Log-in/Log-out status of other extensions. For more information, refer to "1.8.2 Incoming Call Distribution Group Monitor".



**Customizing Your Phone**

- 3.1.3 Customizing the Buttons  
 Create or edit a Log-in/Log-out button, a Log-in/Log-out of a specified group button or a Wrap-up button.

## 1.8.2 Incoming Call Distribution Group Monitor

- Monitoring the Status of Waiting Calls
- Monitoring and Changing the Log-in/Log-out Status of Extensions

The extension assigned as a Supervisor extension can monitor and control the status of other extensions in an incoming call distribution group. It should have a PT with 6-line display. The display and DSS buttons show as follows:

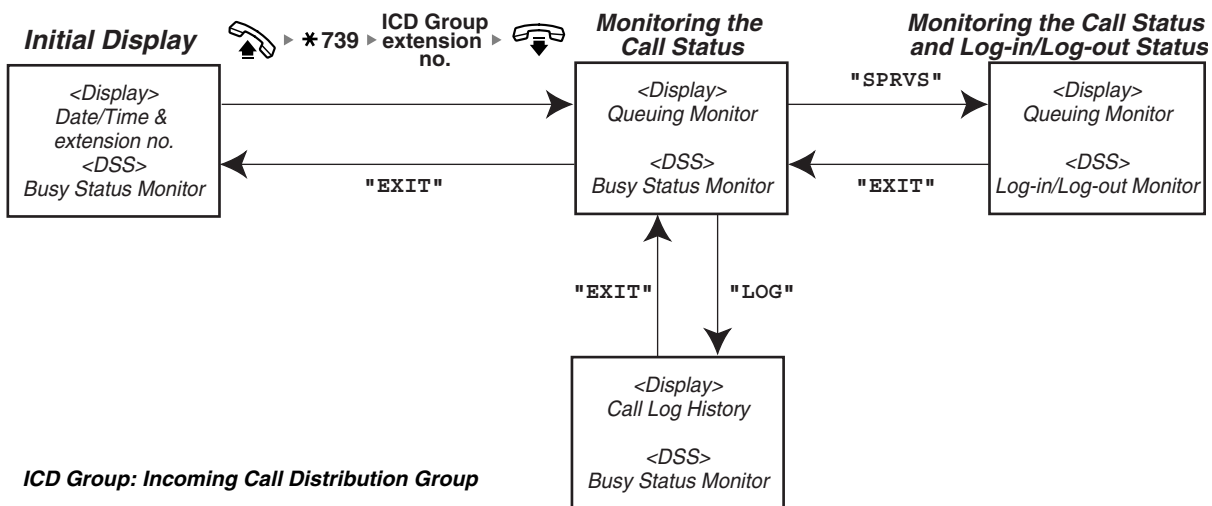

## ◆◆ Monitoring the Status of Waiting Calls

The Supervisor extension can monitor the status of calls waiting to be answered in the queue. If an incoming call distribution group has an overflowed call, the display shows the status automatically. The following information is displayed.

### <Queuing Monitor>

- The current date/time
- The ICD Group extension number/name
- The number of waiting calls
- The longest waiting time

### <Call Log History>

- The date/time when cleared at last time
- The total number of received calls
- The number of overflowed calls
- The number of unanswered calls
- The average waiting time of queuing calls

### To monitor

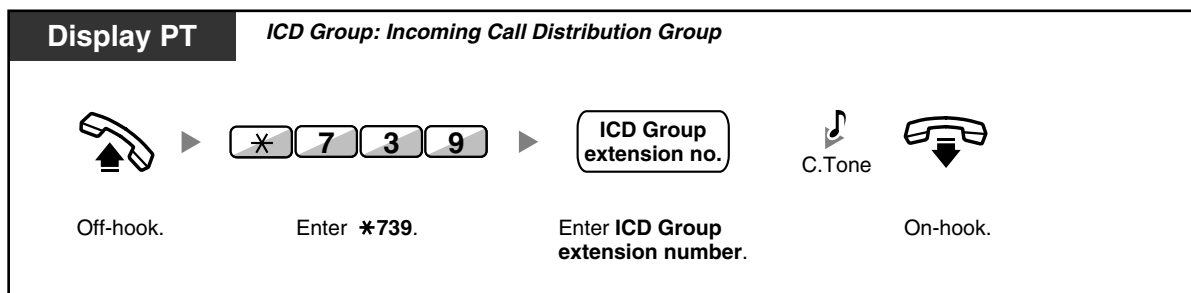

### To clear Call Log History



- The accumulated data is cleared.  
"\*\*\*\*\*" shows if the number to be displayed exceeds the maximum displayable digits.

## ◆◆ Monitoring and Changing the Log-in/Log-out Status of Extensions

The Supervisor extension can monitor the Log-in/Log-out status of the incoming call distribution group members by the DSS button light. It can also change their Log-in/Log-out status if needed.

### To monitor

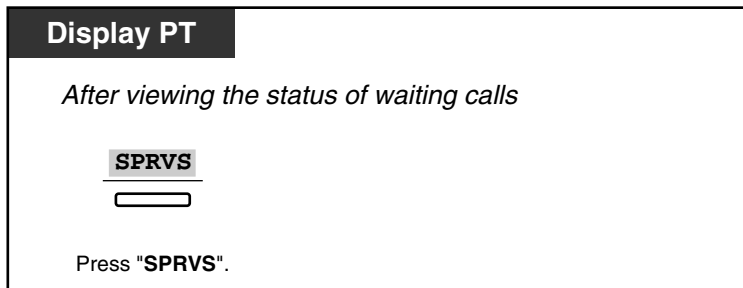

### To change the Log-in/Log-out mode

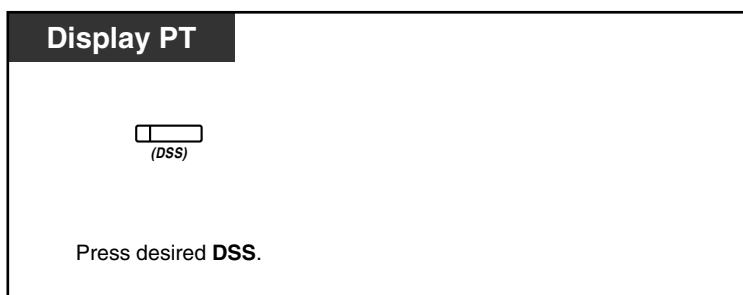

- The DSS button light shows the current status as follows:
  - Off:** The extension is not in the group.
  - Green on:** Log-in (Ready) mode
  - Flashing green:** Log-in (Not Ready) mode
  - Red on:** Log-out mode

## 1.8.3 Manual Queue Redirection

When your incoming call distribution group is busy and other outside calls arrive, the arriving calls are put in a waiting queue.

Extensions can check the status of the queue with the Hurry-up button light, and forward the longest waiting call in the queue to a preset destination manually.

This feature is also known as Hurry-up Transfer.

### To forward the waiting call

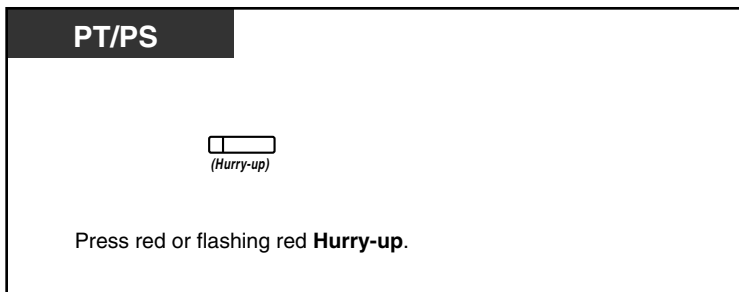

- The Hurry-up button light shows the current status as follows:
  - Off:** No waiting call.
  - Red on:** Some calls are waiting.
  - Flashing red:** The number of calls exceeds the manual queue redirection level.



### Customizing Your Phone

- 3.1.3 Customizing the Buttons
  - Create or edit a Hurry-up button.

## 1.9 User-supplied Equipment

### 1.9.1 Doorphone/Door Opener

You can talk to a person at the door through the doorphone. Preprogrammed extensions or an outside party can receive the calls from the doorphone. You can open the door.

- Doorphone Call
- Door Open

#### ◆◆ Doorphone Call

##### To call from the doorphone

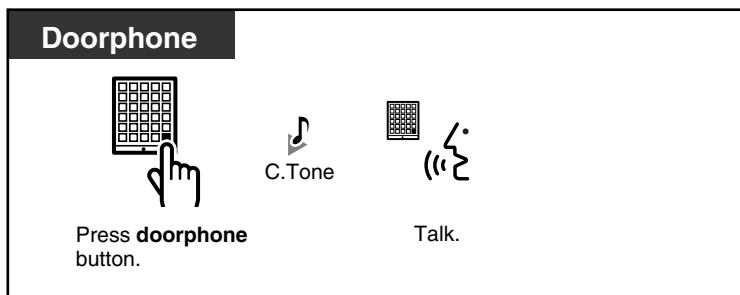

##### To answer a call from the doorphone



##### To call the doorphone

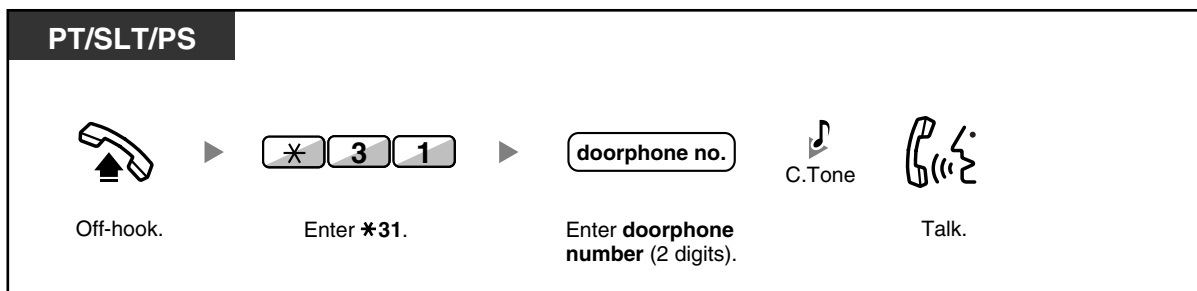

- If no one answers a doorphone call within a specified time period, the call is canceled.

## ◆◆ Door Open

Some extensions may be prohibited from using this feature.

### From a specified extension

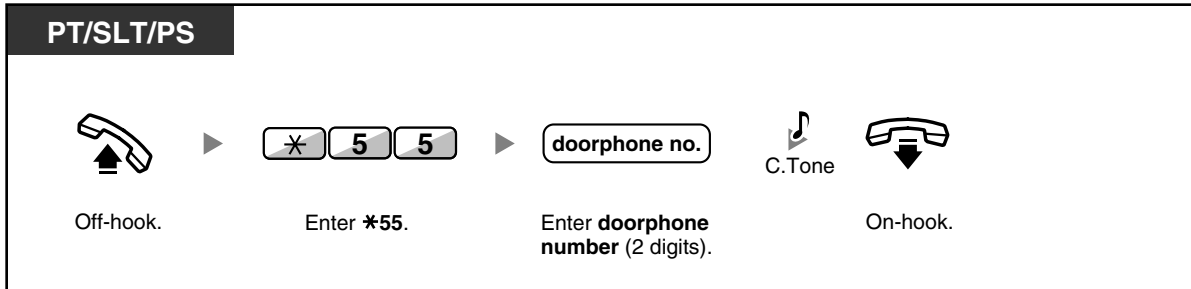

### From any extension while talking to the doorphone

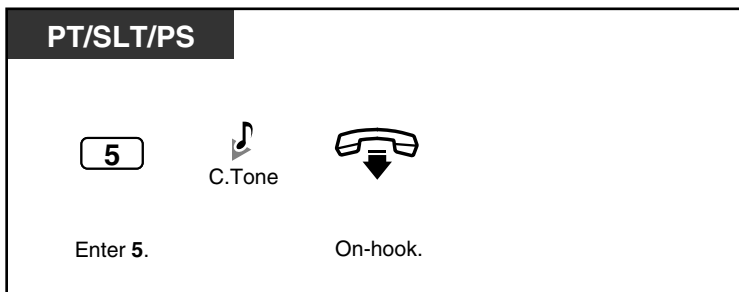

- The door open will be triggered for a specified time period.

## 1.9.2 External Relay

Preprogrammed extensions can switch on a relay (e.g., alarm) connected to the PBX.

### To switch on the relay

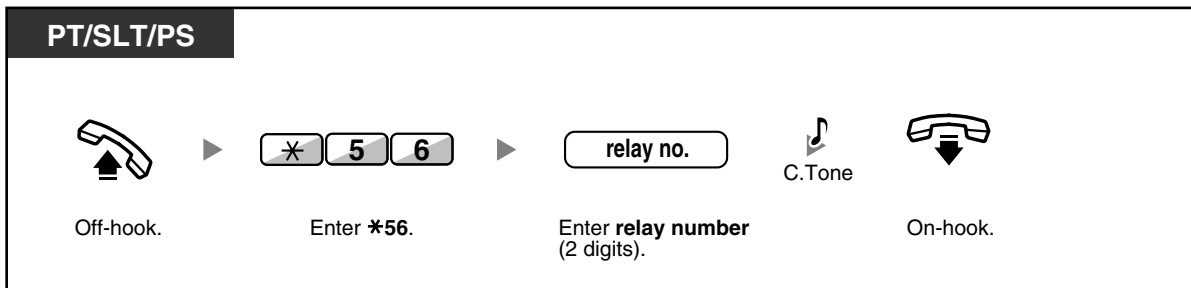

- The relay will be switched off after a specified time period.

### 1.9.3 External Sensor

Preprogrammed extensions can receive an alert call from an external sensor (e.g., security alarm) connected to the PBX.

#### To answer a sensor call

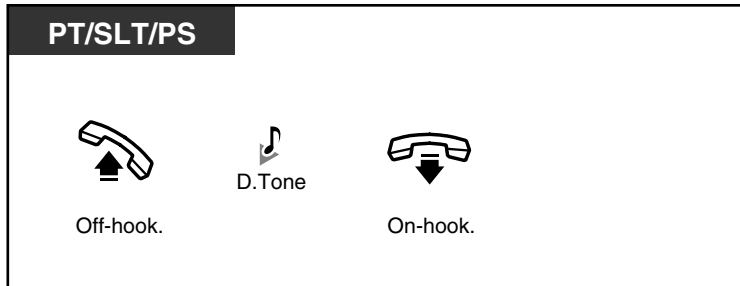

- If you do not answer a sensor call within a specified time period, the sensor call will stop.

### 1.9.4 Host PBX

- External Feature Access (EFA)

#### ◆◆ External Feature Access (EFA)

You can access special features (e.g., Call Waiting) offered by a host PBX or telephone company. This feature is only effective for an outside call.

#### <Example> To hold the current call and then talk to the new party

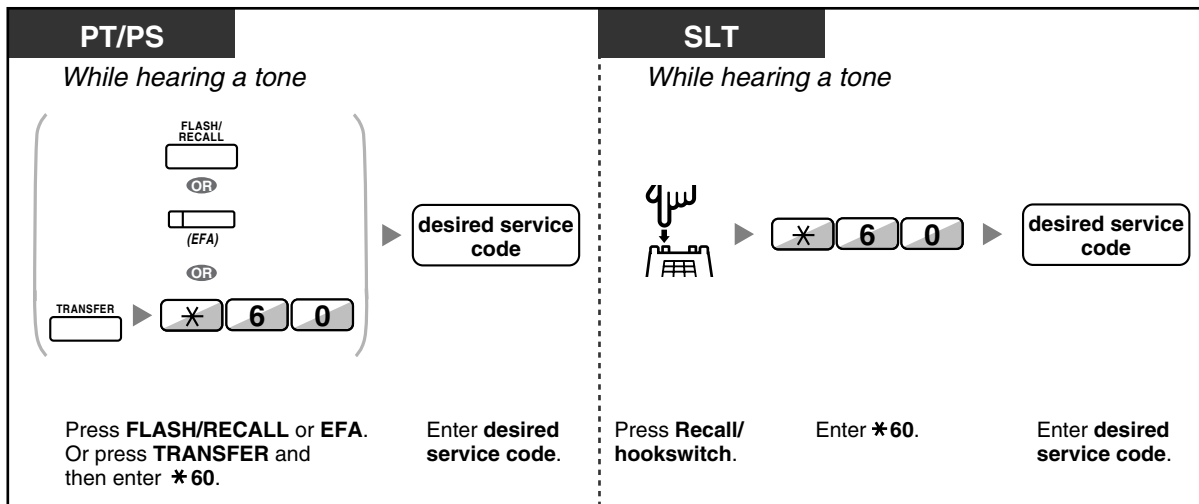

- In this case, FLASH/RECALL button on a proprietary telephone is in the External Feature Access (EFA) mode.
- Regarding the service code, consult your dealer.



**Customizing Your Phone**

- 3.1.3 Customizing the Buttons  
Create or edit an External Feature Access (EFA) button.

## 1.9.5 Voice Processing System

You or an outside party can access the Voice Processing System from a telephone.

- Call Forwarding to Voice Mail (Voice Mail Integration)

If your PBX has a Panasonic Voice Processing System connected (e.g., KX-TVS series) using digital integration, the following features are also available:

- Live Call Screening (LCS)
- Two-way Record

### ◆◆ Call Forwarding to Voice Mail (Voice Mail Integration)

- To forward your calls to your mailbox
- To transfer a call to a mailbox
- To listen to messages

If you cannot answer calls, you can forward them to your mailbox. You can select the type of incoming calls (Intercom Calls/Outside Calls/Both Calls). If your telephone has a Message button, the Message light turns on and lets you know you have messages. Even if a Message button is not provided, you will hear an indication tone\* when going off-hook.

You can also transfer received outside calls to a mailbox so that calling parties can leave messages. If you create a Voice Mail Transfer button on your phone, the transfer is done without knowing the mailbox number (Voice Mail Transfer).

The duration for recording depends on the voice processing system.

#### To forward your calls to your mailbox

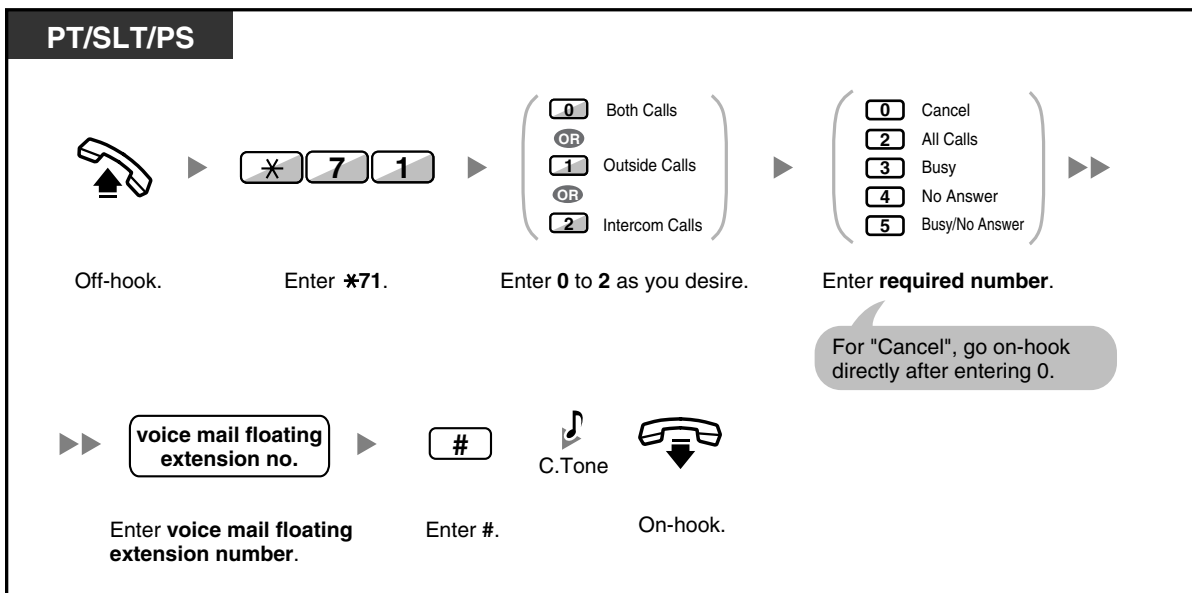



**To transfer a call to a mailbox**

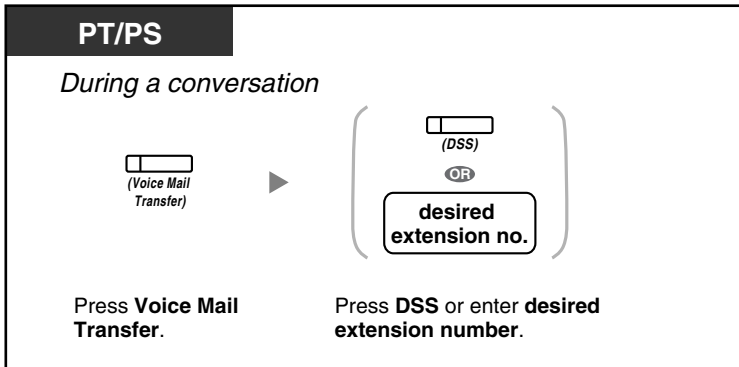

**To listen to messages**

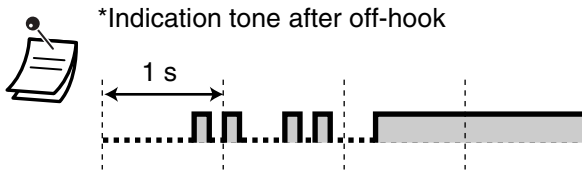
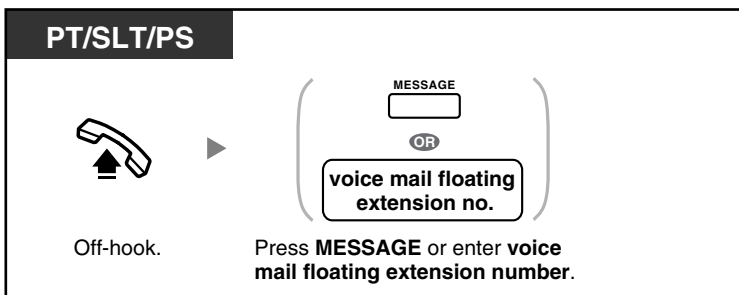

- You can access a voice mail with one-touch.



**Customizing Your Phone**

- 3.1.3 Customizing the Buttons  
Create or edit a Voice Mail Transfer button or a Message button.

**◆◆ Live Call Screening (LCS)**

While a caller is leaving a message in your mailbox, you can monitor the call without answering. If you so desire, you can answer the call while monitoring. There are two methods available (Default: Hands-free mode).

**Hands-free mode:**

You can monitor the message automatically, live through the telephone speaker.

**Private mode:**

You will hear an alarm tone while the caller is leaving a message.

**Before operating**

- Create a Live Call Screening (LCS) button (Personal Programming).
- Select the mode, either Hands-free or Private (Personal Programming).
- Set the extension PIN (Personal Identification Number).

- Set the Live Call Screening feature.

### To set Live Call Screening

**PT/PS** *PIN: Personal Identification Number*



Press **Live Call Screening**.

Enter **extension PIN** (max. 10 digits).

This is required only when an extension PIN is stored.

### To cancel Live Call Screening

**PT/PS**



Press red **Live Call Screening**.

## Operation Flowchart

The operations in the shaded areas can be done hands-free.

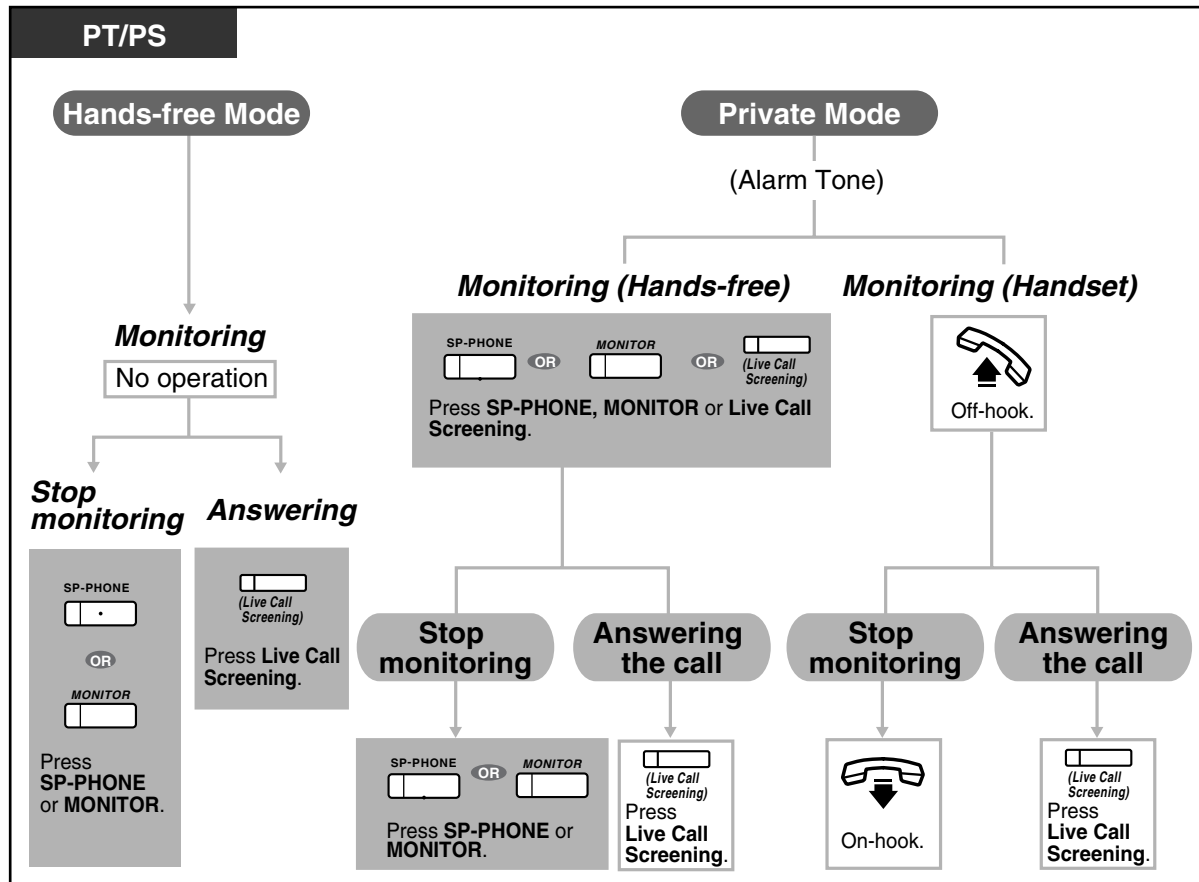

- The Live Call Screening (LCS) button light shows the feature status as follows:
  - Off:** LCS is off.
  - Flashing green rapidly:** Alerting in the Private mode.
  - Flashing green slowly:** Monitoring.
  - Red on:** LCS is on.
- The manager extension can clear an extension PIN.
- This feature is available for a single line telephone if it is connected to a proprietary telephone in parallel. (Private mode only)  
To answer the call while monitoring, press Recall/hookswitch.
- Only the handset monitoring in the Private mode is available for PS users.



### Customizing Your Phone

- 3.1.2 Settings on the Programming Mode—**Live Call Screening Mode Set**  
Select the mode, either monitoring the message through the speaker automatically or receiving, while the caller leaves a message.
- 3.1.3 Customizing the Buttons  
Create or edit a Live Call Screening (LCS) button.

## ◆◆ Two-way Record

You can record a conversation into a mailbox while talking on the phone.  
You can select the mailbox each time you record a conversation.



### To record into your mailbox

**PT/PS**

*During a conversation*

 *(Two-way Record)*

To stop recording, press this button again.

Press **Two-way Record**.

### To record into another mailbox (Two-way Transfer)

**PT/PS**

*During a conversation*

 *(Two-way Transfer)*

Press **Two-way Transfer**.

 *(DSS)*  
OR  
**another extension no.**

Press **DSS** or enter **another extension number**.

To stop recording, press this button again.

### To record into another mailbox with one touch (One-touch Two-way Transfer)

**PT/PS**

*During a conversation*

 *(One-touch Two-way Transfer)*

Press **One-touch Two-way Transfer**.



- The Two-way Record button light, Two-way Transfer button light or One-touch Two-way Transfer button light shows the current status as follows:

**Off:** Not recording.

**On:** Recording the conversation.



- **Note:**  
Many states have imposed regulations on the manner in which 2-way telephone conversations may be recorded, so you should inform the other party that the conversation is being recorded.  
Consult your local telephone company for further information.



#### **Customizing Your Phone**

- 3.1.3 Customizing the Buttons  
Create or edit a Two-way Record button, a Two-way Transfer button and a One-touch Two-way Transfer button.

# 1.10 Walking Extension

## 1.10.1 Walking Extension

You can use the same functions assigned on your previous extension even if you move to another extension in the office.

You can retain your settings such as extension number or One-touch Dialing memory etc. on the new extension.

This feature is also known as Walking Station.

### To set

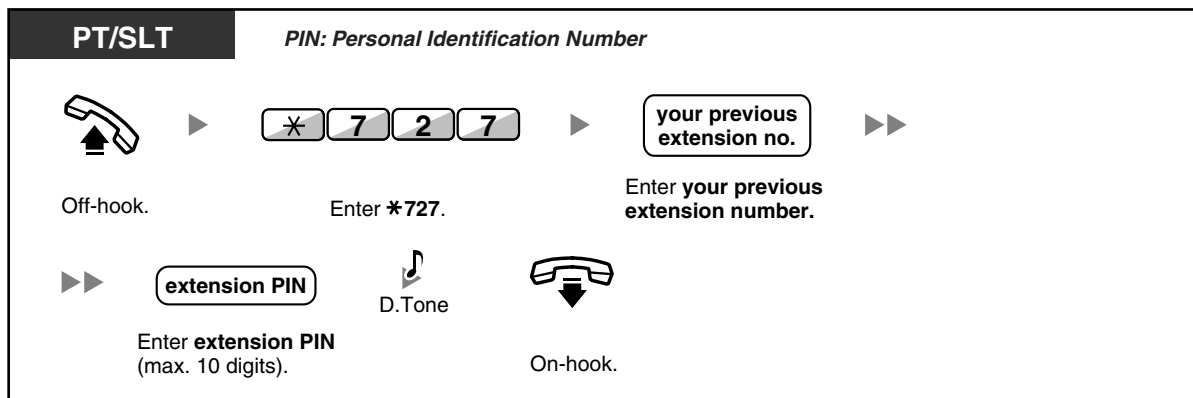

- Your previous extension will get the old settings of your new extension.
- This feature is available for movement between SLT and SLT, PT and PT or SLT and PT.
- For more information, refer to "3.1.1 Personal Programming".

# 1.11 Display Proprietary Telephone

## 1.11.1 Call Log

This is available for the display proprietary telephone and the portable station.

- Incoming Call Log
- Outgoing Call Log

### ◆◆ Incoming Call Log

When you receive an outside call or an external sensor call, call information is recorded automatically in the incoming call log. A preprogrammed number of calls can be logged per extension.

When the call log is full and other call arrives, the oldest call is deleted.

You can modify the logged telephone number.

When the Call Log button light turns on, there is a call which you did not answer.

The following information is logged.

Information	Telephone	3-line display PT except KX-T7735/ KX-T7633/KX-T7630	KX-T7735	1-line or 2-line display PT
	KX-T7636/KX-T7633/KX-T7630			Wireless phone (KX-T7885/KX-TD7895)
	KX-NT136			
	KX-TD7690/KX-TD7680 6-line display PT			
Caller's Name	✓	✓	✓	✓
Date/Time call received	✓	✓	✓	—
Answered or Not Answered				
Confirmed or Not Confirmed	✓	✓	✓	—
Caller's Phone Number	✓	—*	—*	—*

\*: If the caller's name is not logged, the caller's phone number is displayed.  
If the caller's name is logged, the caller's phone number is not displayed.

### To view the log information with the Call Log button

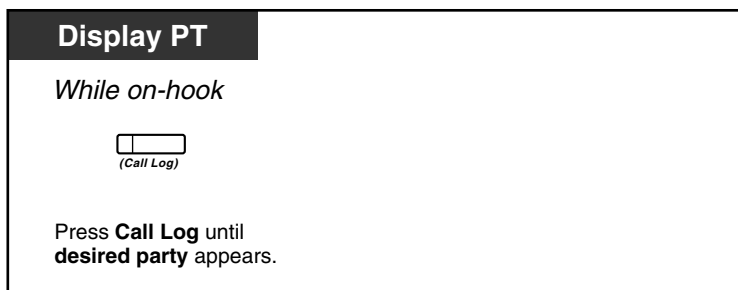

### To view the log information with the Navigator key

**T7600**

*While on-hook*



Press **Left** twice.      Press **Up** or **Down** until **desired party** appears.

### To clear the log information

**Display PT**

*While viewing the log information*



Press **Call Log**, or **Up** or **Down** until **desired party** appears.      Press **TRANSFER**.

### To call

**Display PT**

*While viewing the log information*



Press **Call Log**, or **Up** or **Down** until **desired party** appears.      Off-hook.





- The Call Log button light shows the current status as follows:  
**Off:** No incoming call, or you have already viewed the call log.  
**Red on:** You have missed calls to view.
- If your call is answered by another extension, the caller's information is recorded in the logs of both your extension and the answering extension.
- You can lock your call log by using an extension PIN (Personal Identification Number), so that you can prohibit access to your logged information. Refer to "3.1.2 Settings on the Programming Mode".
- You can also have a Call Log button for an ICD Group (Incoming Call Distribution Group).
- If a call arrives while you are using the call log, the call log display will be replaced with the caller's information.
- For a PS user, refer to "Operating Instructions" for PS.
- Caller information received with a call waiting tone from the telephone company will not be logged in the call log.



### Customizing Your Phone

- 3.1.3 Customizing the Buttons  
Create or edit a Call Log button or Call Log for ICD Group button.

## ◆◆ Outgoing Call Log

You can redial using the outgoing call log.

### To call

T7600

*While on-hook*



Press **Left**.



Press **Up** or **Down** until **desired number** appears.



Off-hook.

### To call with the REDIAL button

Display PT

*While on-hook*

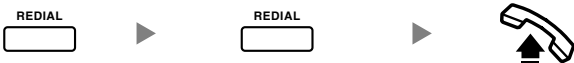

Press **REDIAL** to display the outgoing call log.\*



Press **REDIAL** until **desired number** appears.



Off-hook.



- \* System programming is required for this operation. Consult your dealer.
- This operation is available only for digital proprietary telephones with a display.

### To store the caller's information in personal speed dialing

Display PT

*When the desired party is displayed*



Press **STORE**.



- You can lock your call log by using an extension PIN (Personal Identification Number), so that you can prohibit access to your logged information. Refer to "3.1.2 Settings on the Programming Mode".
- If a call arrives while you are using the call log, the call log display will be replaced with the caller's information.
- For a PS user, refer to "Operating Instructions" for PS.

## 1.11.2 Directories

You can select and call using the directories (*Personal Speed Dialing Directory, System Speed Dialing Directory and Extension Number Directory*).

Only personal directories can be stored, edited or deleted on your extension.

If a call arrives while you are using a directory, the display will be replaced with the caller's information.

- Calling with the Directory
- Storing Names and Numbers
- Entering Characters

### ◆◆ Calling with the Directory

#### To select and call

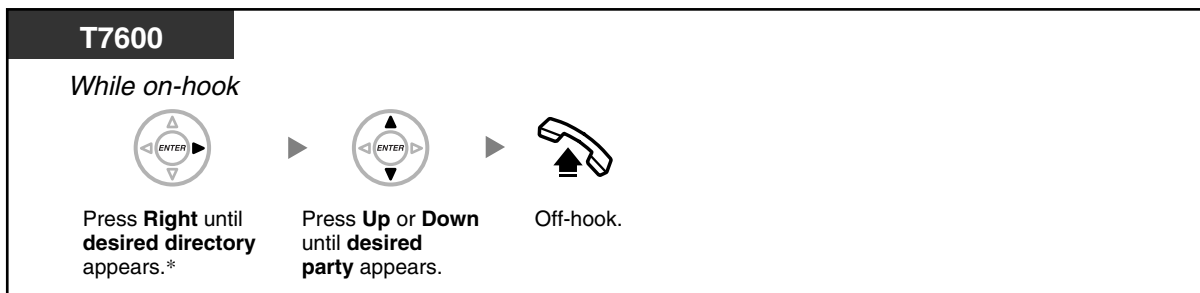

- \* The display order is as follows:  
One time: Personal Speed Dialing Directory  
Two times: System Speed Dialing Directory  
Three times: Extension Number Directory
- To cancel or exit, press the CANCEL or FLASH/RECALL button.



- Directory entries generally should include name and number. If the name is not registered, an entry cannot be displayed.
- The System Speed Dialing Directory can be displayed simply by pressing the AUTO DIAL button while on-hook.

#### To make an intercom call using Extension Number Directory when your telephone accesses an outside line automatically

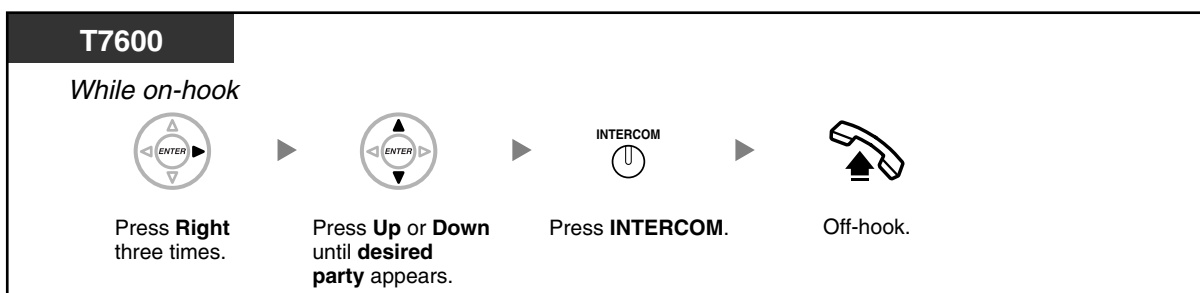

## ◆◆ Storing Names and Numbers

To store a Personal Speed Dialing Directory item

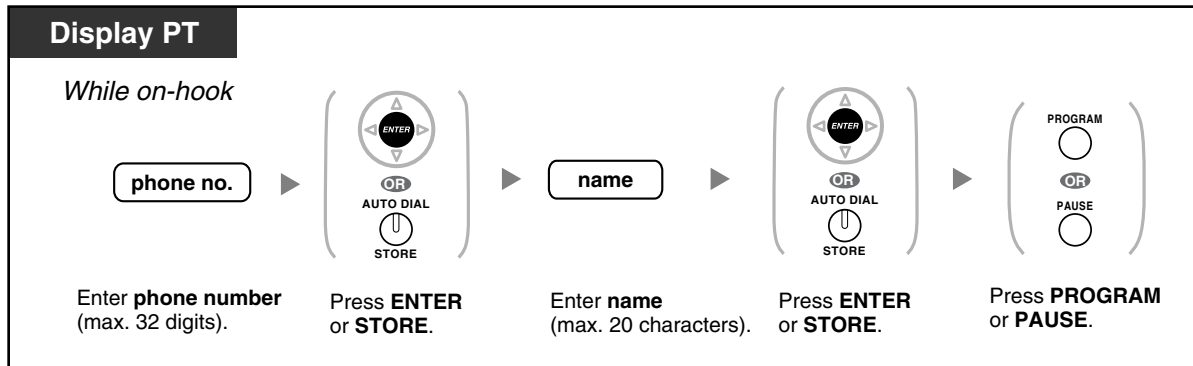

- Telephone number and name on the display are stored using the first spare Personal Speed Dialing memory available.
- For a PS user, refer to "Operating Instructions" for PS.



- For more details, refer to "To store the names and numbers in personal speed dialing" in "3.1.2 Settings on the Programming Mode".

## ◆◆ Entering Characters

You can enter the following characters. The tables show you the characters available for each button. Table 1 or Table 2 can be programmed.

**Table 1 (Standard mode)**

Times Buttons	1	2	3	4	5	6	7	8	9
<b>1</b>	!	?	"	1					
<b>2</b>	A	B	C	a	b	c	2		
<b>3</b>	D	E	F	d	e	f	3		
<b>4</b>	G	H	I	g	h	i	4		
<b>5</b>	J	K	L	j	k	l	5		
<b>6</b>	M	N	O	m	n	o	6		
<b>7</b>	P	Q	R	S	p	q	r	s	7
<b>8</b>	T	U	V	t	u	v	8		
<b>9</b>	W	X	Y	Z	w	x	y	z	9
<b>0</b>	(Space)	.	,	'	:	;	0		
<b>*</b>	/	+	-	=	<	>	*		
<b>#</b>	\$	%	&	@	(	)	€	£	#

Table 2 (Option mode)

Times Buttons	1	2	3	4	5	6	7	8	9	10	11	12	13	14	15
1	!	?	"	ä	ö	ü	1								
2	A	B	C	a	b	c	À	Á	Â	Ã	Ä	Å	Æ	Ç	2
3	D	E	F	d	e	f	Ð	È	É	Ê	Ë	3			
4	G	H	I	g	h	i	Ì	Í	Î	Ï	4				
5	J	K	L	j	k	l	5								
6	M	N	O	m	n	o	Ñ	Ò	Ó	Ô	Õ	Ö	Ø	Œ	6
7	P	Q	R	S	p	q	r	s	Š	ß	7				
8	T	U	V	t	u	v	Û	Ú	Û	Ü	8				
9	W	X	Y	Z	w	x	y	z	Ý	Ž	9				
0	(Space)	.	,	'	:	;	0								
*	/	+	-	=	<	>	*								
#	\$	%	&	@	(	)	€	£	#						

## 1.11.3 System Feature Access

You can access a feature with the "Feature Access" menu.

To access "Feature Access" menu and select the feature

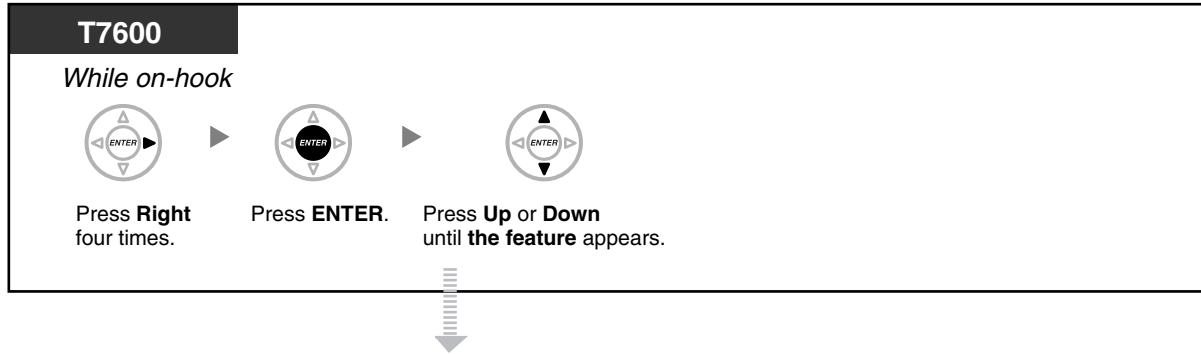

Features	Refer to
Automatic Callback Busy Cancel	1.2.4 When the Dialed Line is Busy or There is No Answer
Group Call Pickup	1.3.3 Call Pickup
Directed Call Pickup	1.3.3 Call Pickup
Doorphone Call	1.9.1 Doorphone/Door Opener
Door Open	1.9.1 Doorphone/Door Opener
External Background Music	2.1.4 External Background Music (BGM)
Paging	1.6.1 Paging





---

## **Section 2**

# ***Manager Operation***

*This chapter shows the manager how to control the other extensions or the PBX.*

## 2.1 Control Features

### 2.1.1 Extension Control

The manager extension can control the settings of other extensions.

- Changing the Settings of Other Extensions

#### ◆◆ Changing the Settings of Other Extensions

##### Remote Extension Lock

This feature is also known as Remote Station Lock Control.

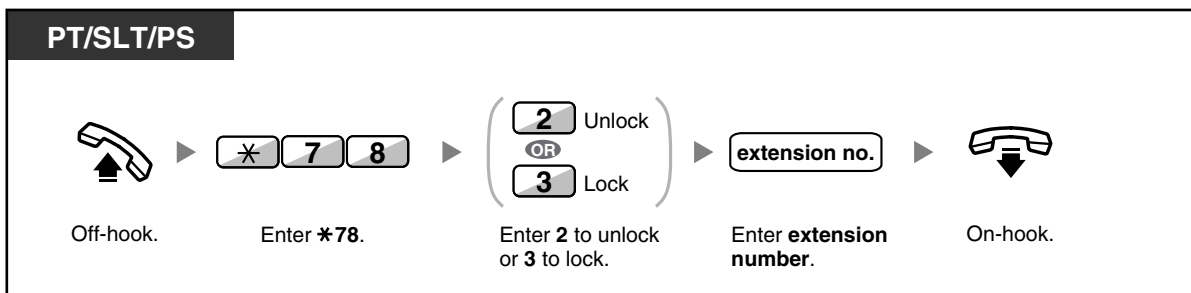

- If your extension is unlocked by the Remote Extension Lock feature, the Extension Lock assigned by itself will be unlocked.

### 2.1.2 Time Service Mode Control

The manager extension or the preprogrammed extension can change the time mode (Day, Lunch, Break or Night).

There are two methods (Automatic or Manual) of changing the time modes.

**Automatic:** enables the time mode for each day of the week to change automatically. You may also change it manually.

**Manual:** enables to change a mode in manual as follows.

#### To change the time mode (Day/Night/Lunch/Break)

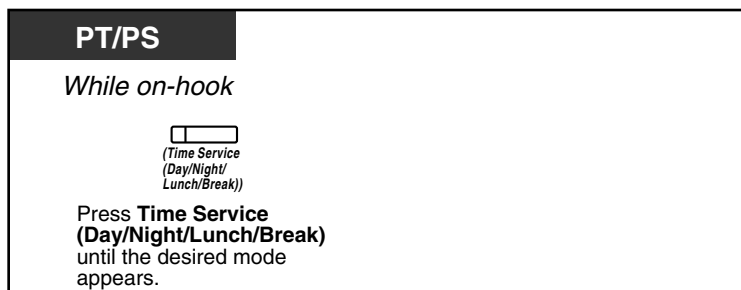

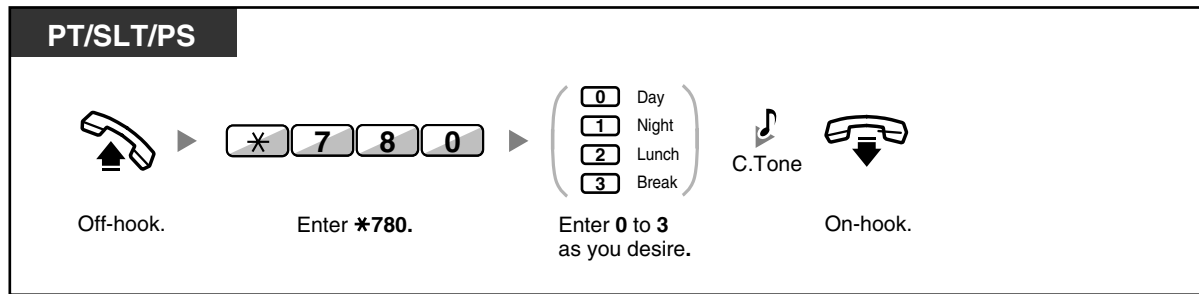

### To select the time service switching mode (Automatic/Manual)

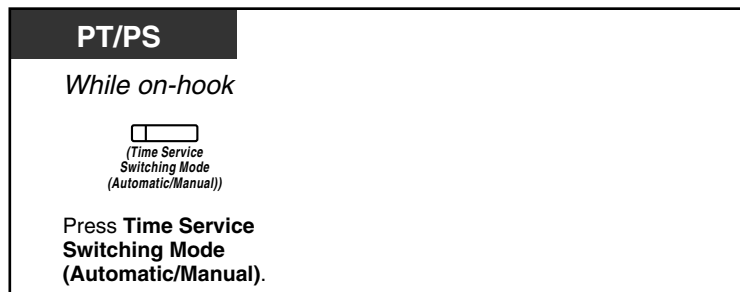

- Besides the time mode, there is Holiday mode. It can change mode once on a specified date.
- The Time Service (Day/Night/Lunch/Break) button light shows the current status as follows:
  - Off:** Day mode
  - Green on:** Lunch mode
  - Flashing green:** Break mode
  - Red on:** Night mode
  - Flashing red:** Holiday mode
- The Time Service Switching Mode (Automatic/Manual) button light shows the current status as follows:
  - Off:** Automatic
  - Red on:** Manual

### Customizing Your Phone

- 3.1.3 Customizing the Buttons  
Create or edit a Time Service (Day/Night/Lunch/Break) button or a Time Service Switching Mode (Automatic/Manual) button.

## 2.1.3 Dial Tone Transfer

The manager can change the restriction level, permitting an extension to make a call.

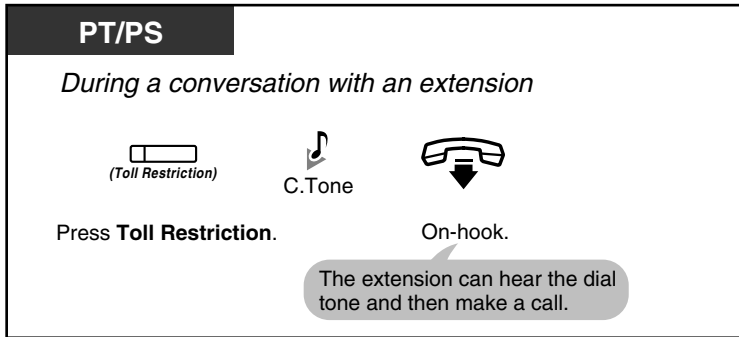

- The restriction level is changed to the preprogrammed level of Toll Restriction button.



### Customizing Your Phone

- 3.1.3 Customizing the Buttons  
Create or edit a Toll Restriction (TRS) button.

## 2.1.4 External Background Music (BGM)

The manager extension can select and broadcast background music in the office through external speakers.

### To select and start/stop the background music

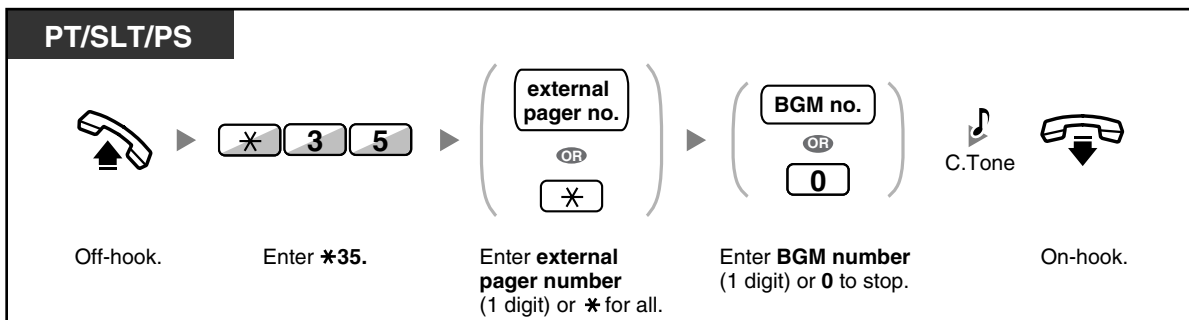

## 2.1.5 Outgoing Messages (OGM)

The manager extension can record three kinds of greeting messages (OGM) as follows:

1. **DISA message:** Used to greet and guide callers so that they access extension group or outside party without operator assistance.
2. **Incoming Call Distribution Group message:** Used to greet and guide callers to an incoming call distribution group.
3. **Timed Reminder message:** Used for a wake-up call message when the extension answers the Timed Reminder.



All messages have their own extension numbers. You can select the desired message. You have two methods for recording a message. One is recorded using the handset, and the other is recorded from an external BGM (MOH) port.

### To record

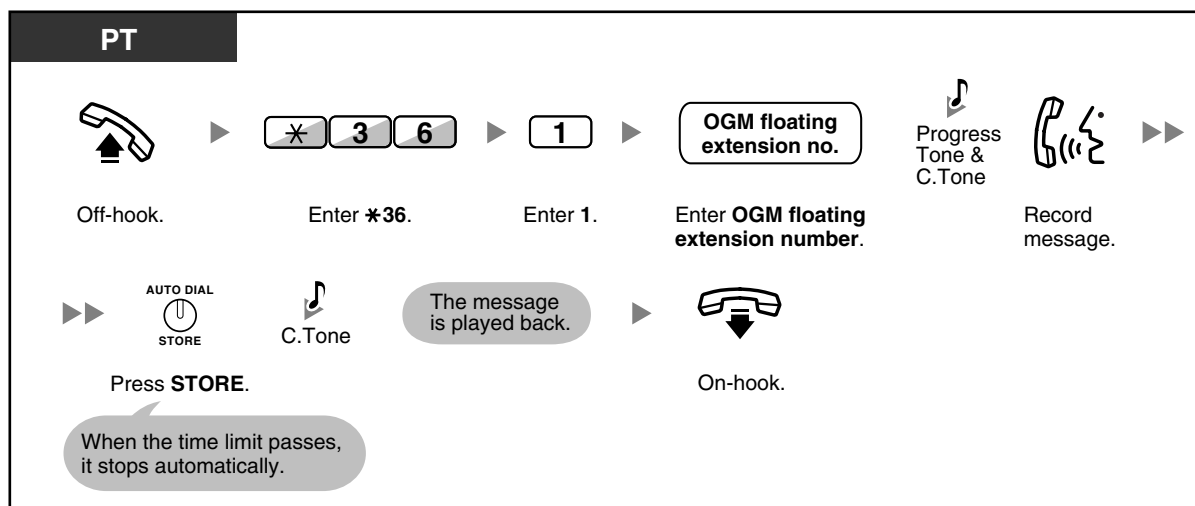

### To play back

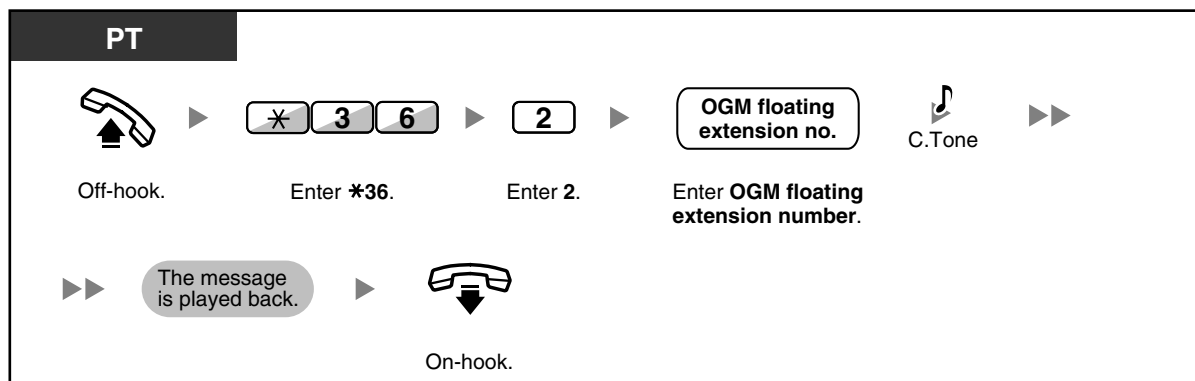

### To record from an external BGM (MOH) port

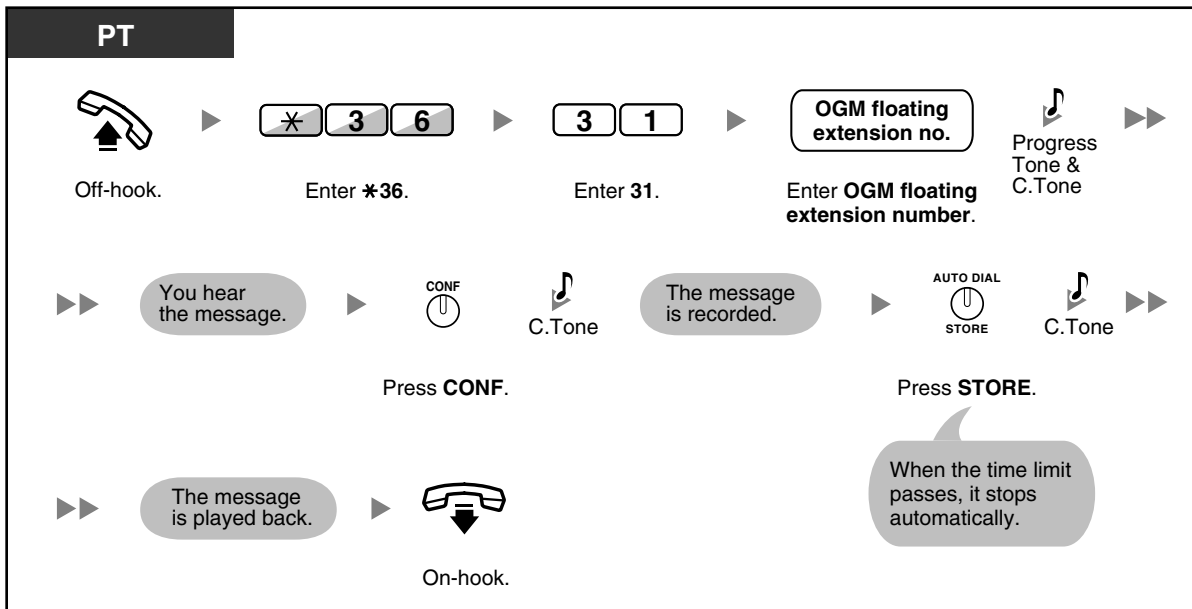

### To clear the message

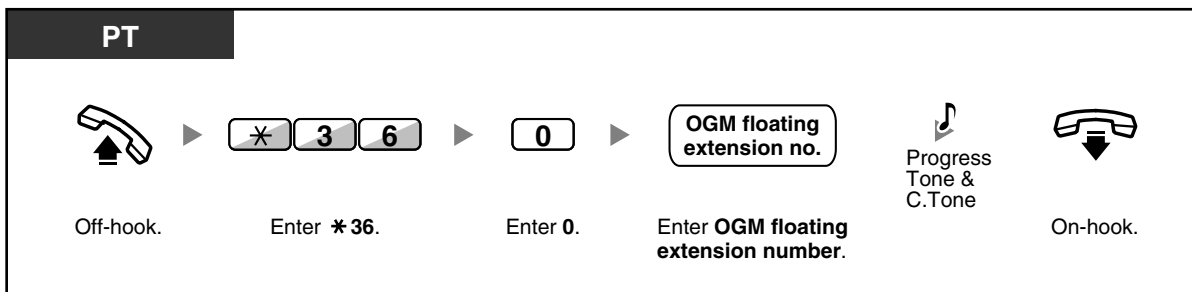

- Record voice messages only; avoid the recording of music.

## 2.1.6 Hospitality Features

The hotel operator can check in or check out guests from his extension. When the hotel operator presses a flexible button assigned as "Check-in" or "Check-out" on his extension, the extension will switch to Room Status Control mode, and the DSS button light will show the current room status of extensions. Other features can also be used in a hotel-type environment.

- Check-in
- Check-out
- Setting a Timed Reminder to a Room Extension (Remote Wake-up Call)
- Recording room information using a room extension



- The hotel operator must be using a 6-line display PT.
- Each DSS button light shows the current status as follows:  
**Off:** Check-out  
**Red on:** Check-in
- While in Room Status Control mode, the hotel operator extension is considered to be busy.
- While in Room Status Control mode, the display, INTERCOM button, and flexible buttons do not operate for other telephone features.
- Some of the operations in this section require system programming. Consult your dealer.

## ◆◆ Check-in

The hotel operator can change the room status of extensions to check-in by using the Check-in button assigned on his extension.

### To check in

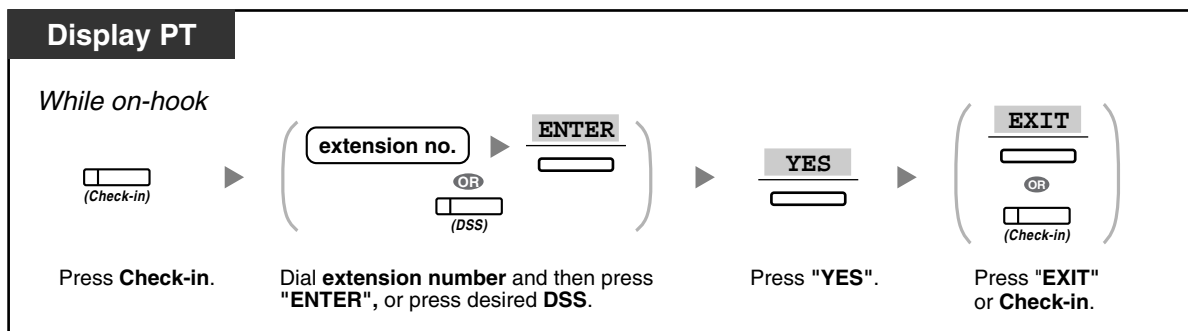

- After check-in, the guest can make outgoing calls from the room extension.
- When the room status of extensions is changed, detailed room status information is recorded automatically. This requires system programming.  
 <Example>

Date	Time	Ext	CO	Dial Number
02/02/00	03:07PM	1234		Check in

## ◆◆ Check-out

The hotel operator can change the room status of extensions to check-out by using the Check-out button assigned on his extension.

### To check out

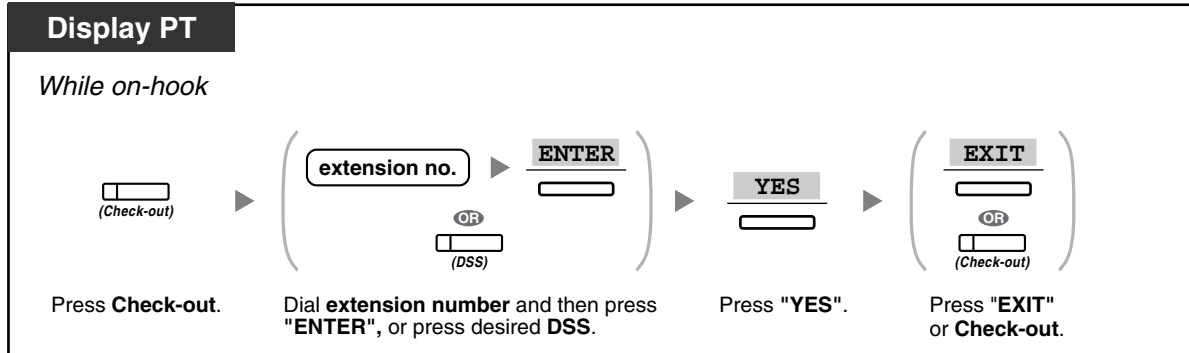

- After check-out, outgoing calls from the room extension will be prohibited.
- After check-out, features set on the room extension will be reset to the default settings. For features that are reset, refer to "1.7.12 Extension Feature Clear".
- After check-out, wake-up call and Call Log information for the room extension will be cleared automatically.
- When the room status of extensions is changed, detailed room status information is recorded automatically. This requires system programming.  
<Example>

Date	Time	Ext	CO	Dial Number
02/03/00	08:08AM	1234		Check out



## ◆◆ Setting a Timed Reminder to a Room Extension (Remote Wake-up Call)

The hotel operator can remotely set/cancel a Timed Reminder to a room extension. He can also confirm the current setting.

### To set

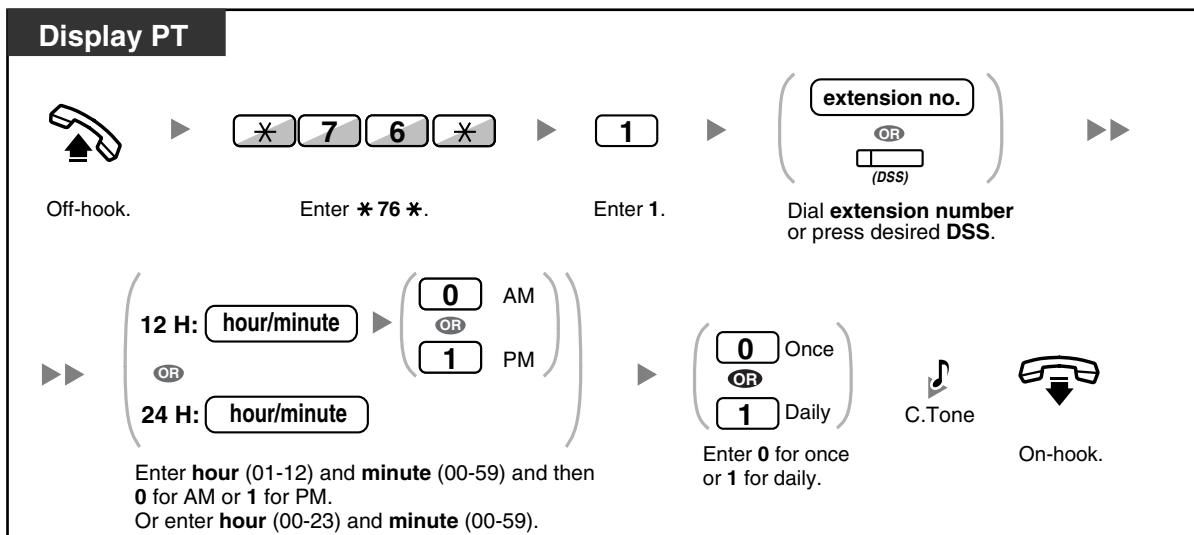

### To cancel

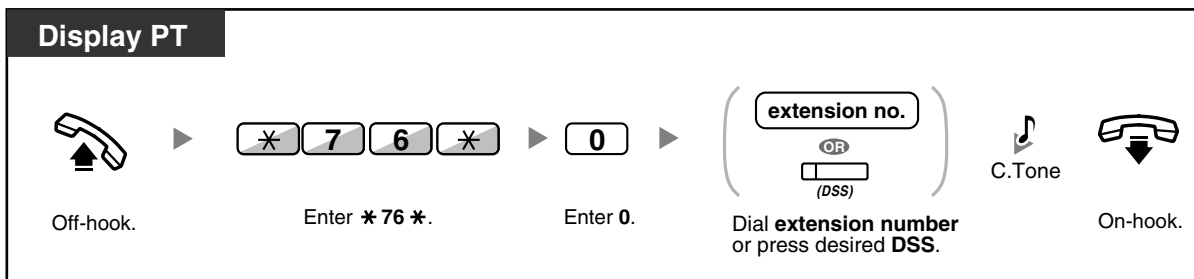

### To confirm

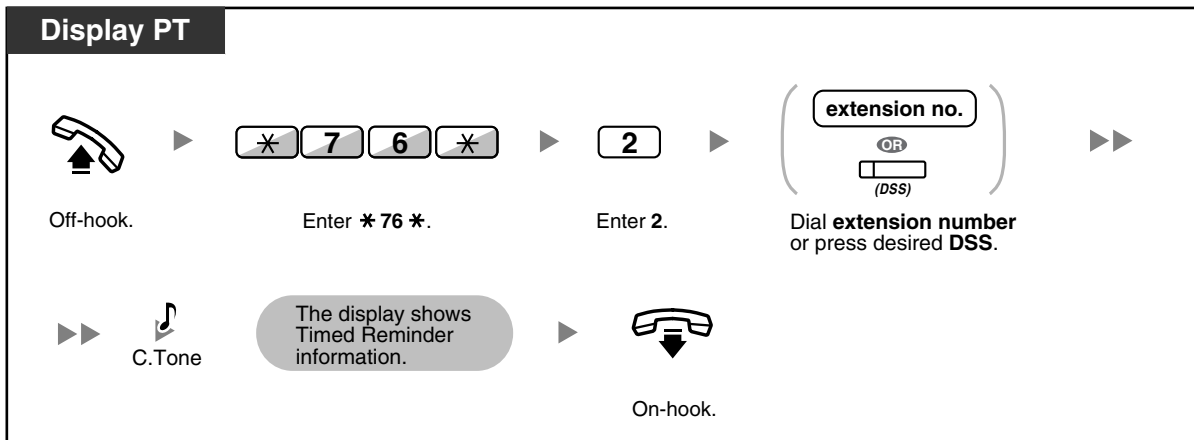



- Timed Reminder can also be set from the room extension. The most recent setting will be valid no matter which extension made the setting.
- When a Timed Reminder starts, and when it is answered or not answered, detailed Timed Reminder information is recorded automatically. This requires system programming.  
<Example>

Date	Time	Ext	CO	Dial Number
02/02/00	02:45PM	1234		Timed Reminder/Start
02/02/00	02:46PM	1234		Timed Reminder/No Answer
02/02/00	02:47PM	1234		Timed Reminder/Answer

**Recording room information using a room extension**

Room information can be recorded from a room extension using up to 8 preprogrammed messages (1-8). Depending on the content of the messages, a variety of information can be recorded. For a list of preprogrammed messages, consult your dealer.

**To record**

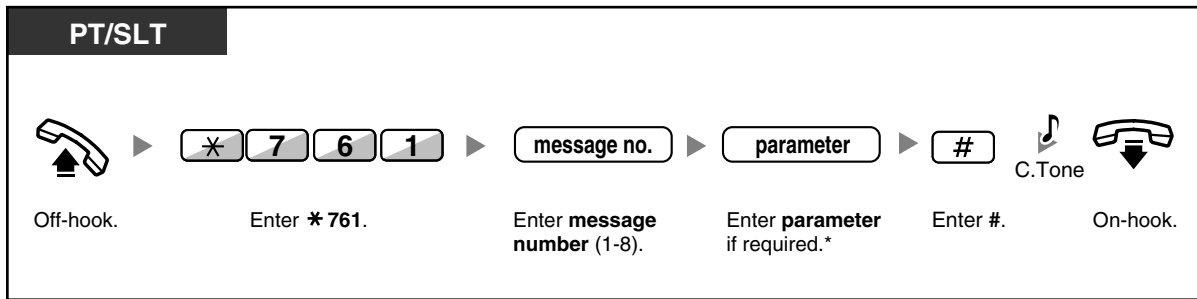

- \* If you see "%" signs, you are required to enter a parameter. Enter values in the "%" positions using 0 to 9 or \*.
- <Example>  
If "Snack %%.%" has been preprogrammed as message number 1 (for recording charges for room snacks consumed), hotel employees would enter data as in the example below using the room extension:

\* 761                 1                 0300                 #  
                           |                 |  
                           message no.    parameter  
   (Snack charge)

Data similar to the example below is recorded.

Date	Time	Ext	CO	Dial Number
02/02/00	10:45AM	1234		Snack 03.00

## 2.1.7 Network Direct Station Selection (NDSS) Monitor Release

NDSS buttons can be customized on any extension connected to your PBX. An NDSS button allows an extension user to monitor another extension connected to another PBX in a private network. The NDSS button light shows the current status of the monitored extension. When it becomes unnecessary to monitor an extension connected to another PBX, the manager can stop the PBX from monitoring it. Any NDSS buttons set to monitor that extension will also stop monitoring.

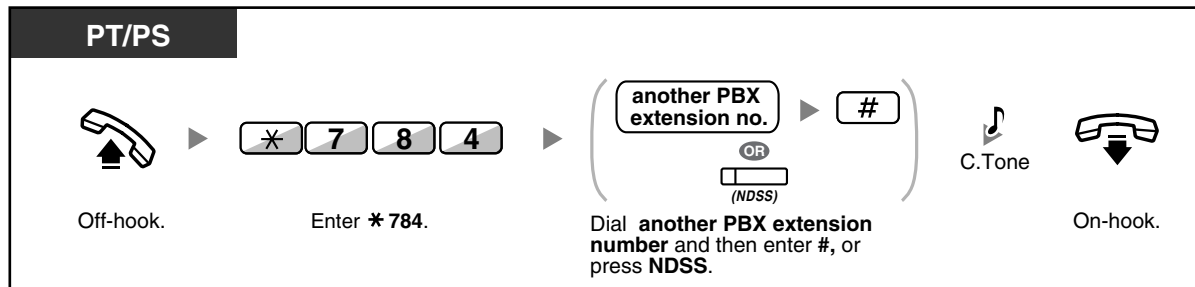

- To restart monitoring of an extension after performing this operation, go off-hook, press the corresponding NDSS button, and go on-hook.



### Customizing Your Phone

- 3.1.3 Customizing the Buttons  
Create or edit a Network Direct Station Selection (NDSS) button.



---

## **Section 3**

# ***Customizing Your Phone & System***

*This chapter shows you how to customize your individual telephone or PBX according to your needs. Find the desired setting and program as necessary.*

## 3.1 Personal Programming

### 3.1.1 Personal Programming

You can customize your telephone features. For example, you can change the initial settings or button features according to your needs.

- Extension PIN (Personal Identification Number)



- If you change your desk and extension, refer to "1.10.1 Walking Extension".

#### ◆◆ Extension PIN (Personal Identification Number)

You can assign a password to each extension.  
The following features require an extension PIN.

1. Screening calls (Live Call Screening [LCS])
2. Prohibiting other people from seeing your personal directory and call log (Directory and Call Log Lock)
3. Using the same settings as your extension at other extensions (Walking Extension)
4. Remote Control Operation (Walking COS)
5. Extension Lock Clear

#### To set

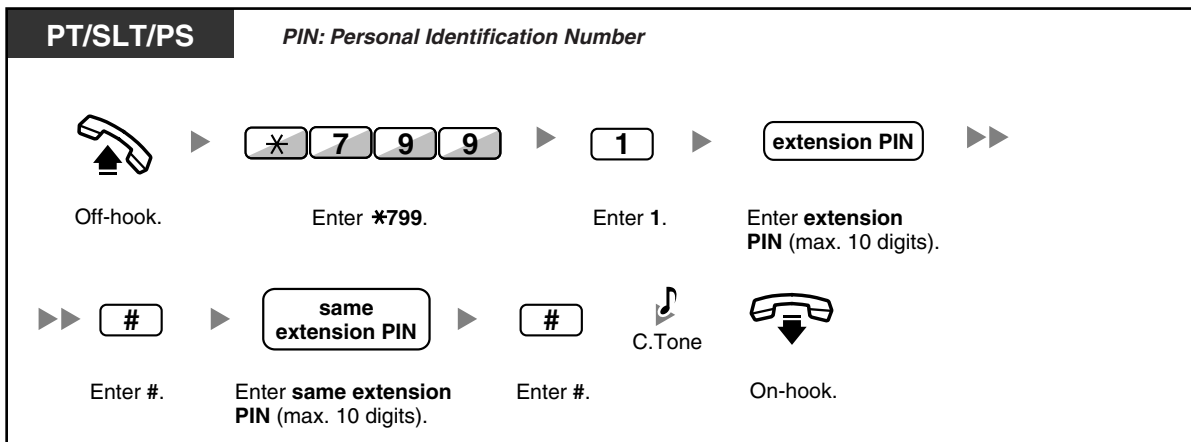

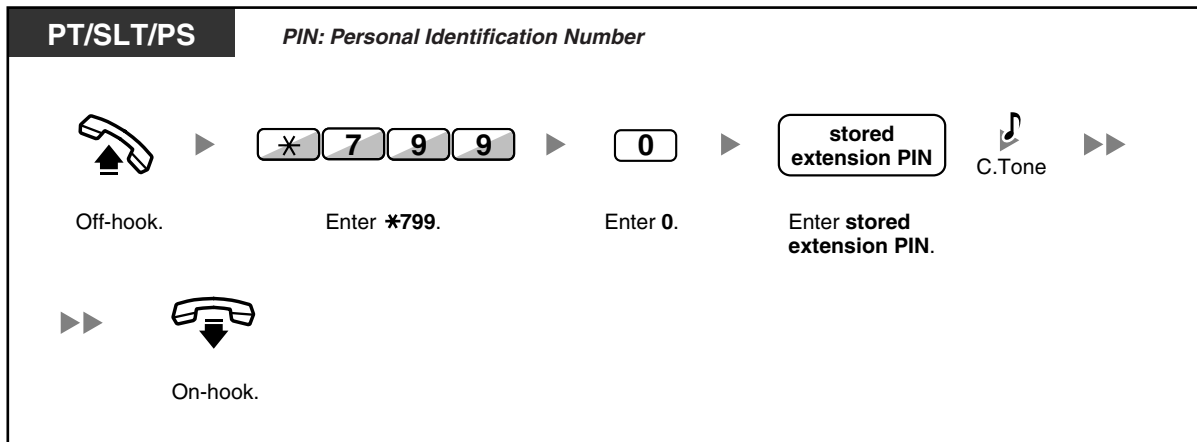
**To cancel**

- **WARNING**  
When a third party discovers the password (extension PIN) of the PBX, there will be a risk that they will make fraudulent phone calls using the telephone line, and the cost will be charged to your own account. In order to avoid this problem, we strongly recommend the following points:
  - a) Carefully maintain the secrecy of the PIN.
  - b) Specify a complicated PIN as long and random as you can make it.
  - c) Change the PIN frequently.
- Valid numbers for an extension PIN are "0" through "9".
- If the wrong extension PIN is entered for a preprogrammed number of times, the PIN is locked.
- If you forget your extension PIN or your extension PIN is locked, your manager can clear the extension PIN and extension PIN lock.

### 3.1.2 Settings on the Programming Mode

You can program features using the programming mode.

- Setting Features
- Clearing Features



- To exit at any time, lift the handset.
- To enter the programming mode when using a PS, refer to "Operating Instructions" for PS.

## ◆◆ Setting Features

The default settings are shown in bold letters. For later reference, place a check mark in the boxes below to indicate your customized setting.

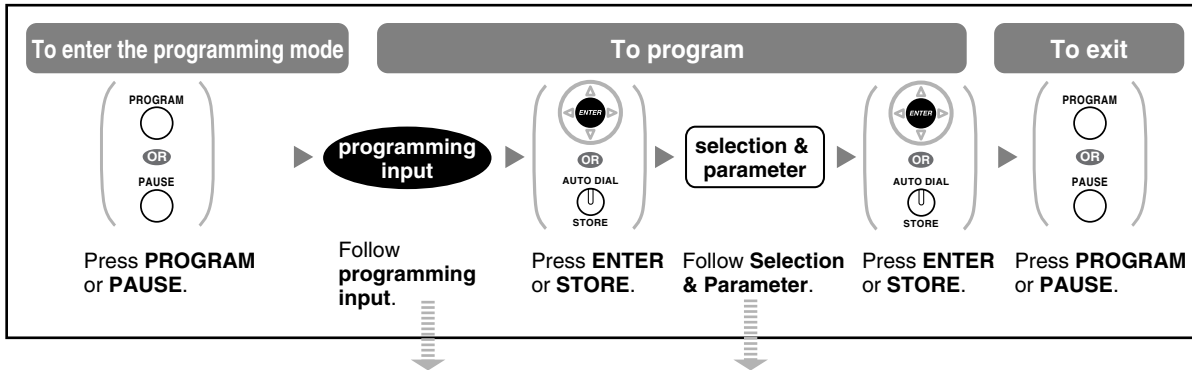



Item	Programming Input	Selection & Parameter
Your extension information	<input type="text" value="0"/> <input type="text" value="0"/>	<p>PT: The display shows the PBX number, slot number and port number. &lt;example&gt;</p> <p>EXT1050:10308  PBX no. <input type="text" value="1"/> <input type="text" value="1"/> <input type="text" value="1"/> Port no.  Slot no.</p> <p>PS: The display shows the PS number. &lt;example&gt;</p> <p>EXT3001:99001  <input type="text" value="1"/> PS no.</p>
Preferred display contrast level from the 4 levels available. (Display Contrast Selection)*1	<input type="text" value="0"/> <input type="text" value="1"/>	<input type="text" value="1"/> <input type="checkbox"/> Light
		<input type="text" value="2"/> <input type="checkbox"/> Little Light
		<input type="text" value="3"/> <input type="checkbox"/> <b>Little Dark</b>
		<input type="text" value="4"/> <input type="checkbox"/> Dark
Which display language do you prefer? (Display Language Selection)	<input type="text" value="0"/> <input type="text" value="2"/>	<input type="text" value="1"/> <input type="checkbox"/> <b>English</b>
		<input type="text" value="2"/> <input type="checkbox"/> 2nd Language
		<input type="text" value="3"/> <input type="checkbox"/> 3rd Language
		<input type="text" value="4"/> <input type="checkbox"/> 4th Language
		<input type="text" value="5"/> <input type="checkbox"/> 5th Language



Item	Programming Input	Selection & Parameter	
Would you like the call duration to be shown automatically on the display when answering an outside call? (Display Switching Mode)	0 3	0	<input type="checkbox"/> No—Manual (The display keeps showing all of the outside caller's information unless you change it to the call duration manually.)
		1	<input type="checkbox"/> <b>Yes—Automatic (The first line of the display will change to the call duration automatically when you answer an outside call.)</b>
Would you like to turn on the display backlight of the KX-T7633/KX-T7636? (Display Backlight Selection)*1	0 4	0	<input type="checkbox"/> Yes—ON in use
		1	<input type="checkbox"/> <b>Yes—always ON</b>
		2	<input type="checkbox"/> No—always OFF
Would you like to dial a preset number simply by going off-hook?	1 1	desired no. (max. 32 digits)	
		0	<input type="checkbox"/> <b>Do not use</b>
		1	<input type="checkbox"/> Use
Should you prevent your number being displayed on the called party's telephone? (Calling Line Identification Restriction [CLIR])	1 3	0	<input type="checkbox"/> <b>No—Allows your number to be displayed</b>
		1	<input type="checkbox"/> Yes—Prevent your number being displayed
Which number should be displayed on the called party's telephone? (Calling Line Identification Presentation [CLIP])	1 4	0	<b>Caller ID assigned to your extension</b>
		1	Caller ID assigned on the CO line being used

### 3.1 Personal Programming

Item	Programming Input	Selection & Parameter	
Which do you prefer to seize when you go off-hook to make calls? (Preferred Line Assignment—Outgoing)	1 9	0	<input type="checkbox"/> No line
		1	<input type="checkbox"/> An idle CO line
		2 + CO button no.*2 (01-36) or  (CO)	<input type="checkbox"/> A CO/G-DN button
		3 or INTERCOM 	<input type="checkbox"/> Intercom
Which line do you prefer to answer when you go off-hook? (Preferred Line Assignment—Incoming)	2 0	0	<input type="checkbox"/> No line
		1	<input type="checkbox"/> <b>The longest ringing line (when multiple calls arrive)</b>
		2 + CO button no.*2 (01-36) or  (CO)	<input type="checkbox"/> An assigned outside button
How do you prefer to receive an intercom call? (Alternate Receiving—Ring/Voice)*1	2 1	0	<input type="checkbox"/> <b>Ringing (Tone Call)</b>
		1	<input type="checkbox"/> Directly—The party's voice is heard without ringing.
		2	<input type="checkbox"/> Ring only—Prohibiting the caller switching to the voice mode.
Should the single line telephone in parallel ring? (Paralleled Telephone)*1	2 2	0	<input type="checkbox"/> No—The telephone will not ring.
		1	<input type="checkbox"/> <b>Yes—The telephone will ring.</b>
Do you prefer to answer a call without going off-hook regardless of the AUTO ANS button status? (Forced Answerback Selection)*1	2 3	0	<input type="checkbox"/> <b>No—Disable</b>
		1	<input type="checkbox"/> Yes—Enable

Item	Programming Input	Selection & Parameter	
Which service do you prefer when a calling party is recording a message in your mailbox? (Live Call Screening Mode Set)* <sup>1</sup>	2 5	0	<input type="checkbox"/> You can monitor the message through the telephone speaker. ( <b>Hands-free mode</b> )
		1	<input type="checkbox"/> Only an alarm tone is heard. (Private mode)
Would you like to keep recording after answering the call in the LCS mode? (LCS Mode Set [After Answering])	2 6	0	<input type="checkbox"/> <b>No—Stop recording</b>
		1	<input type="checkbox"/> Yes—Keep recording
Do you prefer to receive call waiting for outside calls?	3 0	0	<input type="checkbox"/> No (No tone)
		1	<input type="checkbox"/> <b>Yes (Tone)</b>
Which type of call waiting for intercom calls do you prefer? (Call Waiting Selection)	3 1	0	<input type="checkbox"/> No call
		1	<input type="checkbox"/> <b>Tone</b>
		2	<input type="checkbox"/> Voice announcement through the built-in speaker (OHCA)* <sup>3</sup>
		3	<input type="checkbox"/> Voice announcement through the handset (Whisper OHCA)* <sup>3</sup>
Which type of call waiting tone do you prefer? (Call Waiting Tone Type Selection)	3 2	0	<input type="checkbox"/> <b>Tone 1</b>
		1	<input type="checkbox"/> Tone 2
Would you like to show a message on the caller's telephone display? (Absent Message)	4 0	0	<input type="checkbox"/> <b>No—Off</b>
		message no. (1-8)	<input type="checkbox"/> Yes—Shows the selected message.
		9	<input type="checkbox"/> Yes—Shows your personal message.
Creating your personal message. (Personal Absent Message)	4 1	message (max. 16 characters)	

### 3.1 Personal Programming

Item	Programming Input	Selection & Parameter	
Where are your incoming calls forwarded or refused? (Call Forwarding [FWD]/Do Not Disturb [DND])	<div style="display: flex; flex-direction: column; align-items: center;"> <div style="display: flex; align-items: center; margin-bottom: 10px;"> <span style="border: 1px solid black; padding: 2px 5px;">5</span> <span style="border: 1px solid black; padding: 2px 5px;">0</span> / <span style="margin: 0 5px;">○</span> <small style="font-size: 8px;">FWD/DND</small> </div> <div style="margin-bottom: 10px;">(for both calls)</div> <div style="display: flex; align-items: center; margin-bottom: 10px;"> <span style="border: 1px solid black; padding: 2px 5px;">5</span> <span style="border: 1px solid black; padding: 2px 5px;">1</span> </div> <div style="margin-bottom: 10px;">(for outside calls)</div> <div style="display: flex; align-items: center; margin-bottom: 10px;"> <span style="border: 1px solid black; padding: 2px 5px;">5</span> <span style="border: 1px solid black; padding: 2px 5px;">2</span> </div> <div>(for intercom calls)</div> </div>	<span style="border: 1px solid black; padding: 2px 5px;">0</span>	<input type="checkbox"/> <b>Off</b>
		<span style="border: 1px solid black; padding: 2px 5px;">1</span>	<input type="checkbox"/> Do Not Disturb (DND)
		<span style="border: 1px solid black; padding: 2px 5px;">2</span> + desired no. (max. 32 digits)	<input type="checkbox"/> All—Forward all calls
		<span style="border: 1px solid black; padding: 2px 5px;">3</span> + desired no. (max. 32 digits)	<input type="checkbox"/> Busy—Forwarded when your extension is busy.
		<span style="border: 1px solid black; padding: 2px 5px;">4</span> + desired no. (max. 32 digits)	<input type="checkbox"/> No Answer—Forwarded when you do not answer.
<span style="border: 1px solid black; padding: 2px 5px;">5</span> + desired no. (max. 32 digits)	<input type="checkbox"/> Busy/No Answer—Forwarded when you do not answer or when your extension is busy.		
To set the timer for "No Answer" and "Busy/No Answer". (FWD N/A Timer)	<span style="border: 1px solid black; padding: 2px 5px;">5</span> <span style="border: 1px solid black; padding: 2px 5px;">3</span>	<input type="text"/> (0-120) seconds (Default: 15 seconds)	
Should you prohibit other people from picking up your calls? (Call Pickup Deny)	<span style="border: 1px solid black; padding: 2px 5px;">6</span> <span style="border: 1px solid black; padding: 2px 5px;">0</span>	<span style="border: 1px solid black; padding: 2px 5px;">0</span>	<input type="checkbox"/> <b>No—Allow</b>
		<span style="border: 1px solid black; padding: 2px 5px;">1</span>	<input type="checkbox"/> Yes—Deny
Do you use the headset? (Headset Operation)* <sup>1</sup>	<span style="border: 1px solid black; padding: 2px 5px;">6</span> <span style="border: 1px solid black; padding: 2px 5px;">1</span>	<span style="border: 1px solid black; padding: 2px 5px;">0</span>	<input type="checkbox"/> <b>No—Headset off</b>
		<span style="border: 1px solid black; padding: 2px 5px;">1</span>	<input type="checkbox"/> Yes—Headset on
Do you prohibit other people from joining your conversation? (Executive Busy Override Deny)	<span style="border: 1px solid black; padding: 2px 5px;">6</span> <span style="border: 1px solid black; padding: 2px 5px;">2</span>	<span style="border: 1px solid black; padding: 2px 5px;">0</span>	<input type="checkbox"/> <b>No—Allow</b>
		<span style="border: 1px solid black; padding: 2px 5px;">1</span>	<input type="checkbox"/> Yes—Deny
Would you like to prohibit paging announcements? (Paging Deny)* <sup>1</sup>	<span style="border: 1px solid black; padding: 2px 5px;">6</span> <span style="border: 1px solid black; padding: 2px 5px;">3</span>	<span style="border: 1px solid black; padding: 2px 5px;">0</span>	<input type="checkbox"/> <b>No—Allow</b>
		<span style="border: 1px solid black; padding: 2px 5px;">1</span>	<input type="checkbox"/> Yes—Deny
Do you prefer to hear the key pad tone? (Key Pad Tone Set)* <sup>1</sup>	<span style="border: 1px solid black; padding: 2px 5px;">6</span> <span style="border: 1px solid black; padding: 2px 5px;">4</span>	<span style="border: 1px solid black; padding: 2px 5px;">0</span>	<input type="checkbox"/> No—Off
		<span style="border: 1px solid black; padding: 2px 5px;">1</span>	<input type="checkbox"/> <b>Yes—On</b>
Do you want back ground music through your telephone speaker while on-hook? (Background Music [BGM])* <sup>1</sup>	<span style="border: 1px solid black; padding: 2px 5px;">6</span> <span style="border: 1px solid black; padding: 2px 5px;">5</span>	<span style="border: 1px solid black; padding: 2px 5px;">0</span>	<input type="checkbox"/> <b>No—Off</b>
		<span style="border: 1px solid black; padding: 2px 5px;">1</span> + BGM no. (1 digit)	<input type="checkbox"/> Yes—On

Item	Programming Input	Selection & Parameter	
Would you like to set your extension PIN or change a stored extension PIN to new one? (Extension PIN [Personal Identification Number])	<input type="text" value="9"/> <input type="text" value="0"/>	extension PIN (max. 10 digits) + ENTER/STORE + same extension PIN	<input type="checkbox"/> To set an extension PIN
		stored extension PIN + new extension PIN (max. 10 digits) + ENTER/STORE + same extension PIN	<input type="checkbox"/> To change a stored extension PIN to new one
To prevent other people from using your telephone. (Extension Lock)	<input type="text" value="9"/> <input type="text" value="1"/>	<b>extension PIN (max. 10 digits) +</b> <input type="text" value="0"/>	<input type="checkbox"/> <b>To unlock</b>
		extension PIN (max. 10 digits) + <input type="text" value="1"/>	<input type="checkbox"/> To lock
To prevent other people from seeing your personal directory and call log. (Directory and Call Log Lock)* <sup>1</sup>	<input type="text" value="9"/> <input type="text" value="2"/>	<b>extension PIN (max. 10 digits) +</b> <input type="text" value="0"/>	<input type="checkbox"/> <b>To unlock</b>
		extension PIN (max. 10 digits) + <input type="text" value="1"/>	<input type="checkbox"/> To lock
Do you prefer to set the One-touch dialing only? (One-touch Dialing Assignment Mode Selection)	<input type="text" value="#"/> <input type="text" value="*"/>	<input type="text" value="0"/>	<input type="checkbox"/> <b>No—Normal (Any Flexible CO buttons can be modified.)</b>
		<input type="text" value="1"/>	<input type="checkbox"/> Yes—Only One-touch dialing buttons can be modified. However, to modify them, there is no need to enter "2" before the number.

\*1: Not available for a PS

\*2: CO button numbers (25-36) are available only when the Add-on Key Module is attached to your telephone.

\*3: Only available for certain digital proprietary telephones. Consult your dealer.



- **WARNING**  
When a third party discovers the password (extension PIN) of the PBX, there will be a risk that they will make fraudulent phone calls using the telephone line, and the cost will be charged to your own account. In order to avoid this problem, we strongly recommend the following points:
  - a) Carefully maintain the secrecy of the PIN.
  - b) Specify a complicated PIN as long and random as you can make it.
  - c) Change the PIN frequently.
- After the program number is entered, the program title is displayed.  
The programming screen can be changed with the Navigator key (Up or Down).



- You can select the parameter with the Navigator Key (Up or Down) instead of entering a number.

### To store the names and numbers in personal speed dialing

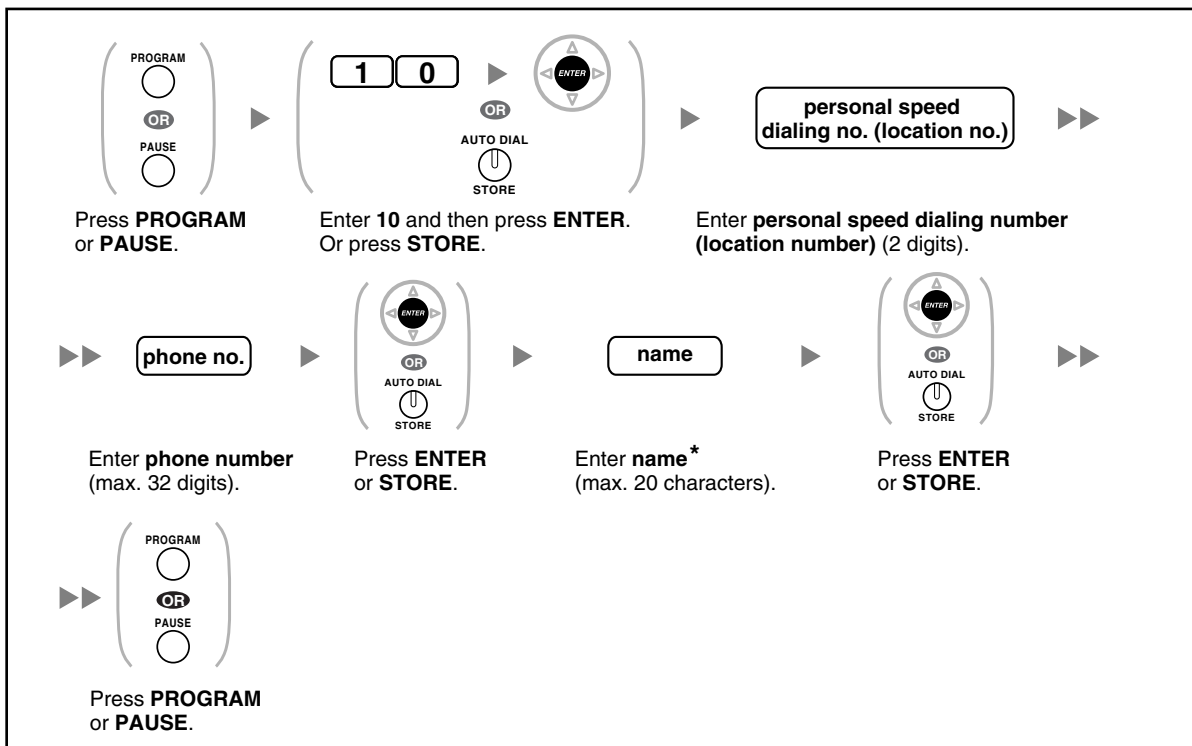

- \* To enter characters, refer to "Entering Characters".
- The maximum number of personal speed dialing numbers (default: 10 numbers, 00-09) can be increased up to 100 numbers. For more details, consult your dealer.

**To edit the names and numbers of personal speed dialing**

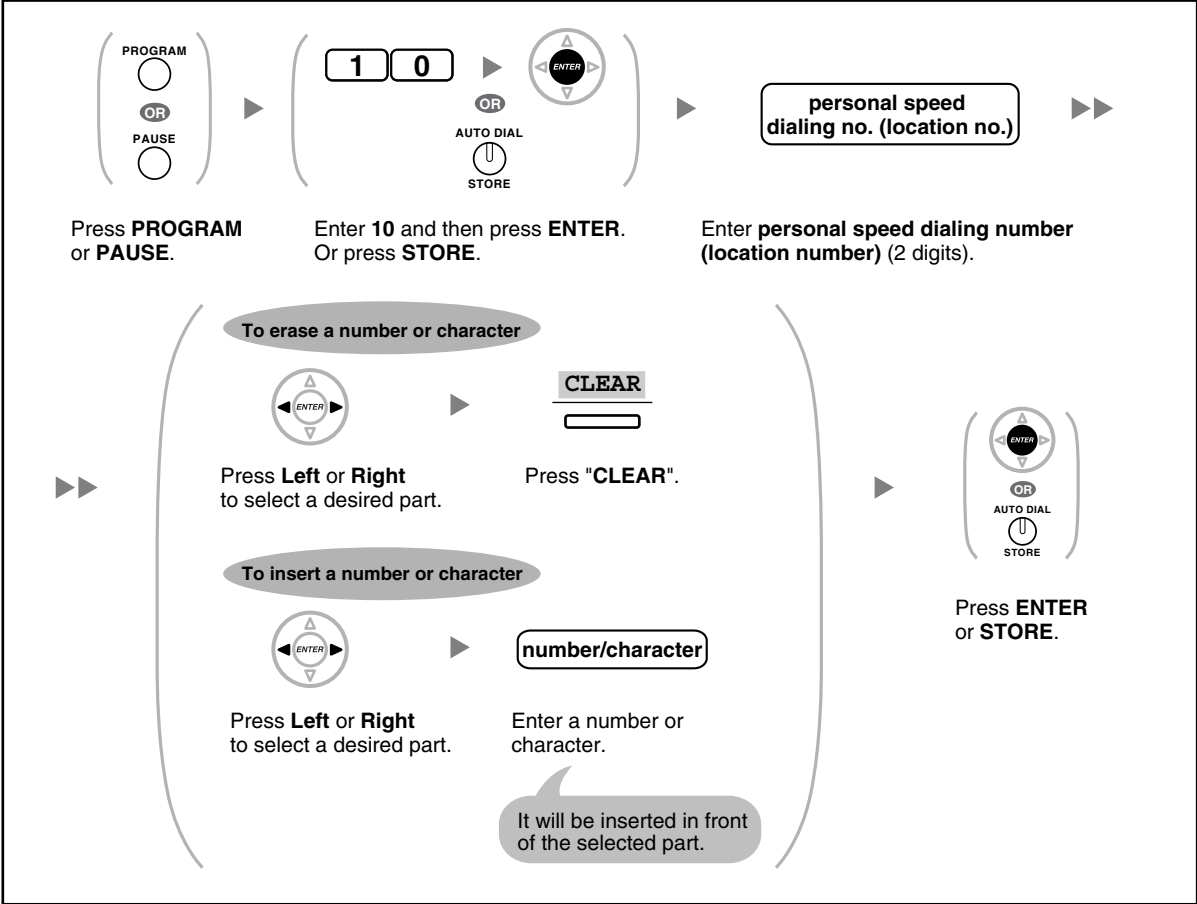

**◆◆ Clearing Features**

You can reset the settings of the following features on your extension to the default settings with one operation.

Features	Default Setting
Display Switching Mode	<b>Automatic</b>
Hot Line	<b>Off</b>
Calling Line Identification Restriction [CLIR]	<b>Allow</b>
Calling Line Identification Presentation [CLIP]	<b>Caller ID assigned on your extension</b>
Preferred Line Assignment—Outgoing	<b>Intercom</b>
Preferred Line Assignment—Incoming	<b>The longest ringing line</b>
Alternate Receiving—Ring/Voice	<b>Ringing (Tone Call)</b>
Paralleled Telephone	<b>Paired SLT will ring</b>
Forced Answerback Selection	<b>Disable</b>
Live Call Screening Mode Set	<b>Hands-free mode</b>

### 3.1 Personal Programming

Features	Default Setting
LCS Mode Set [After Answering]	Stop recording
Call Waiting Selection—Intercom Calls/Outside Calls	Enable (Tone)
Call Waiting Tone Type Selection	Tone 1
Absent Message	Off
Personal Absent Message	Cleared
Call Forwarding [FWD]/Do Not Disturb [DND]—Intercom Calls/Outside Calls	Off
FWD N/A Timer	15 seconds
Call Pickup Deny	Allow
Headset Operation	Headset off
Executive Busy Override Deny	Allow
Paging Deny	Allow
Key Pad Tone Set	On
Background Music [BGM]	Off
Data Line Security	Off
Log-in/Log-out	Log-in
Message Waiting	Off
Timed Reminder	Cleared

#### To set

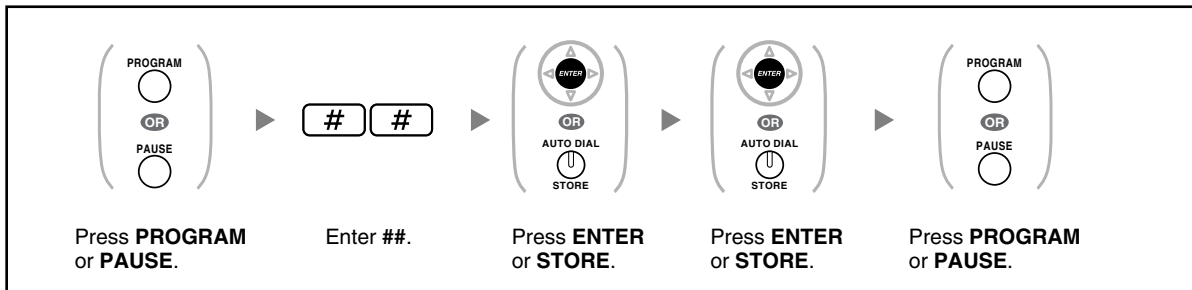

- If you do not desire that the Call Waiting, FWD/DND or Hot Line to be cleared by this feature, please ask your dealer.



### 3.1.3 Customizing the Buttons

You can change the flexible CO buttons/DSS buttons, and programmable feature (PF) buttons on PTs, DSS Consoles, Add-on Key Modules, and PSs to the following function buttons. For example, if your telephone has more CO buttons than available CO lines, you may change unused CO buttons to one-touch buttons.



- To enter the programming mode when using a PS, refer to "Operating Instructions" for PS.

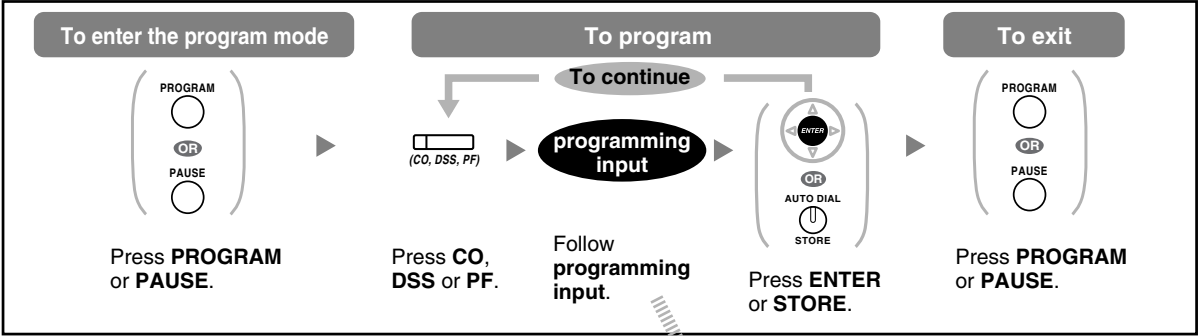

Buttons	Programmable Button			Programming Input
	CO	DSS	PF	
Loop-CO (L-CO)	✓	✓		* (star)
Group-CO (G-CO)	✓	✓		# (hash) + CO line group no. (2 digits)
Single-CO (S-CO)	✓	✓		0 (zero) + CO line no. (3 digits)
Direct Station Selection (DSS)	✓	✓		1 (one) + Extension no.
One-touch Dialing*1	✓	✓	✓	2 (two)*2 + Desired no. (max. 32 digits)
Group Directory Number (G-DN)	✓	✓		3 (three) 0 (zero) + Incoming call distribution group extension no.
Message	✓	✓		4 (four) 0 (zero)
Message for another extension	✓	✓		4 (four) 0 (zero) + Extension no./Incoming call distribution group extension no.
Call Forwarding (FWD)/Do Not Disturb (DND)—Both calls	✓	✓		4 (four) 1 (one)
FWD/DND—Outside calls	✓	✓		4 (four) 2 (two)
FWD/DND—Intercom calls	✓	✓		4 (four) 3 (three)

### 3.1 Personal Programming

Buttons	Programmable Button			Programming Input
	CO	DSS	PF	
Group FWD—Both calls	✓	✓		<b>4</b> <b>4</b> + Incoming call distribution group extension no.
Group FWD—Outside calls	✓	✓		<b>4</b> <b>5</b> + Incoming call distribution group extension no.
Group FWD—Intercom calls	✓	✓		<b>4</b> <b>6</b> + Incoming call distribution group extension no.
Account	✓	✓		<b>4</b> <b>8</b>
Conference	✓	✓		<b>4</b> <b>9</b>
Terminate	✓	✓		<b>5</b> <b>0</b>
External Feature Access (EFA)	✓	✓		<b>5</b> <b>1</b>
Call Park	✓	✓		<b>5</b> <b>3</b> + Parking zone no. (2 digits)
Call Park (Automatic Park Zone)	✓	✓		<b>5</b> <b>3</b> <b>*</b>
Call Log* <sup>3</sup>	✓	✓		<b>5</b> <b>4</b>
Call Log for ICD Group* <sup>3</sup>	✓	✓		<b>5</b> <b>4</b> + Incoming call distribution group extension no.
Log-in/Log-out	✓	✓		<b>5</b> <b>5</b>
Log-in/Log-out of a specified group	✓	✓		<b>5</b> <b>5</b> + Incoming call distribution group extension no.
Log-in/Log-out for all groups	✓	✓		<b>5</b> <b>5</b> <b>*</b>
Hurry-up	✓	✓		<b>5</b> <b>6</b> + Incoming call distribution group extension no.
Wrap-up	✓	✓		<b>5</b> <b>7</b>
System Alarm* <sup>3</sup>	✓	✓		<b>5</b> <b>8</b>
Time Service (Day/Night/Lunch/Break)	✓	✓		<b>5</b> <b>9</b> + 0/1/2/3* <sup>4</sup> (+ <b>#</b> + Tenant no.)
Answer* <sup>3</sup>	✓	✓		<b>6</b> <b>0</b>
Release* <sup>3</sup>	✓	✓		<b>6</b> <b>1</b>

Buttons	Programmable Button			Programming Input
	CO	DSS	PF	
Toll Restriction (TRS)	✓	✓		<b>6</b> <b>2</b> + Toll Restriction (TRS) Level (1-7)
Calling Line Identification Restriction (CLIR)	✓	✓		<b>6</b> <b>4</b>
Connected Line Identification Restriction (COLR)	✓	✓		<b>6</b> <b>5</b>
Headset* <sup>3</sup>	✓	✓		<b>6</b> <b>7</b>
Time Service Switching Mode (Automatic/Manual)	✓	✓		<b>6</b> <b>8</b> (+ Tenant no.)
Network Direct Station Selection (NDSS)* <sup>6</sup>	✓	✓		<b>6</b> <b>9</b> + Another PBX extension no.
CTI	✓			<b>7</b> <b>0</b>
Check-in* <sup>3</sup>	✓	✓		<b>8</b> <b>0</b>
Check-out* <sup>3</sup>	✓	✓		<b>8</b> <b>1</b>
Two-way Record* <sup>5</sup>	✓	✓		<b>9</b> <b>0</b> + Voice mail floating extension no.
Two-way Transfer* <sup>5</sup>	✓	✓		<b>9</b> <b>1</b> + Voice mail floating extension no.
One-touch Two-way Transfer* <sup>5</sup>	✓	✓		<b>9</b> <b>1</b> + Voice mail floating extension no. + # + Extension no./Incoming call distribution group extension no.
Live Call Screening (LCS)* <sup>5</sup>	✓	✓		<b>9</b> <b>2</b>
Voice Mail Transfer* <sup>5</sup>	✓	✓		<b>9</b> <b>4</b> + Voice mail floating extension no.



- \*1 "\*", "#", FLASH/RECALL, PAUSE, SECRET (INTERCOM) and T (Transfer) can also be stored.

If you do not want to display the stored number when making a call, press the SECRET (INTERCOM) button before and after the numbers you wish to conceal.

If you store an outside party's number, you should first store a line access number.

If you need to enter an account code, you can enter the specified account code before the line access number.

<Example>

<u>*49</u>	<u>1234</u>	<u>#</u>	<u>9</u>	<u>SECRET</u> <u>123 4567</u>
Account code feature no.	Account code	Account code delimiter	Automatic line access number	Phone number

### 3.1 Personal Programming

- \*2 For a PF button, "2" is not required to enter before the desired number.
- \*3 This button is not available for a PS.
- \*4 0: Day/Night/Lunch/Break, 1: Day/Night/Break, 2: Day/Night/Lunch, 3: Day/Night
- \*5 This button is used for the integrated voice mail features.
- \*6 The button may not be available depending on the networking method in use or the settings of the PBX. For more details, consult your dealer.
- **To exit at any time**, lift the handset.



- You can select the parameter with the Navigator key (Up or Down) instead of entering a number.

#### To distinguish the ringing tones for each CO, INTERCOM or G-DN button (Digital proprietary telephone only)

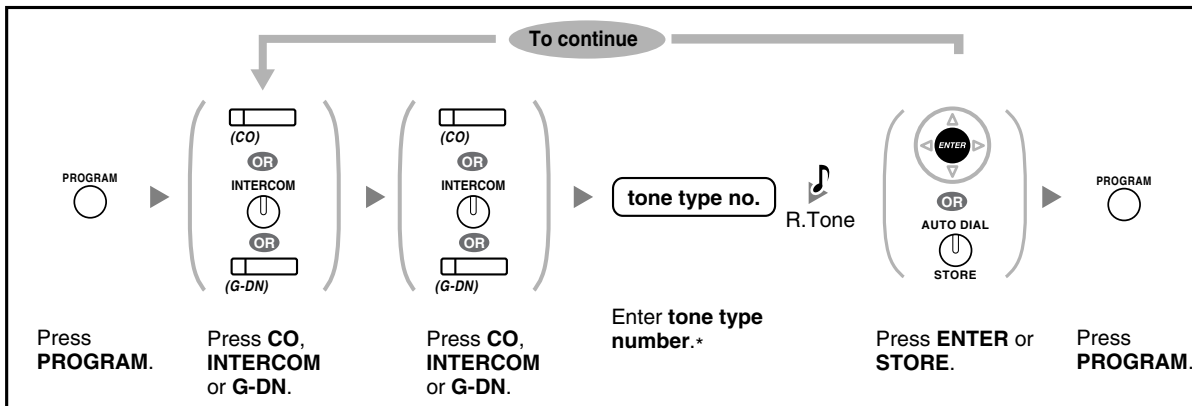

- \* Available tone types vary depending on the telephone you are using:
  - KX-T7600 series: Tone types "01" to "30" are available.
  - Other telephones: Only tone types "01" to "08" are available. It is possible to enter a tone type number from "09" to "30", but you will hear tone type "02".

#### To clear the button

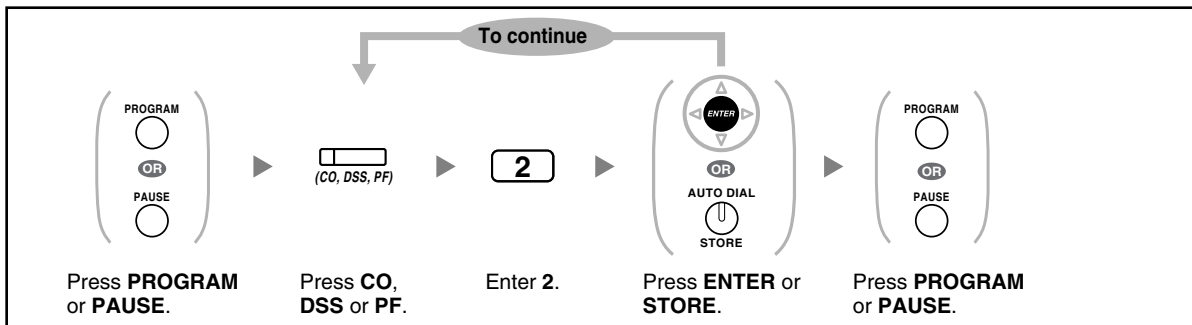

## 3.2 Manager Programming

### 3.2.1 Programming Information

The manager can program the following item.

- Other Extensions Control

#### **Available Extension**

The extension assigned as a manager

#### **Required Telephone**

A Panasonic Proprietary Telephone with display (over 2 lines)  
(e.g., KX-T7636)

#### **Manager Password**

To enter programming mode, the manager password (max. 10 digits) is required. (Default: 1234)

#### **Conditions**

The programming extension must be idle, on-hook and holding no calls.

## 3.2.2 Manager Programming

### ◆◆ Changing the Settings and Extension Control

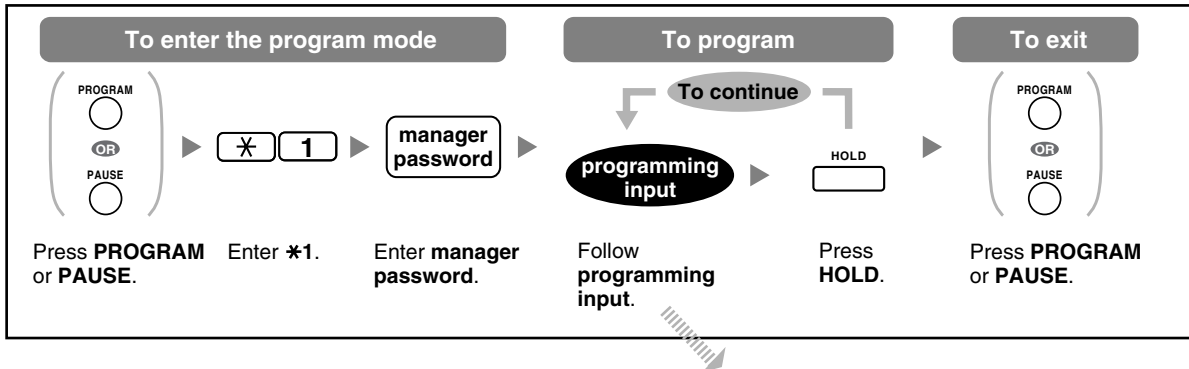

Item	Programming Input
Changing the manager password.	[0] [0] +  + Password (max. 10 digits) +
Locking/unlocking other extensions. (Remote Extension Lock)	[9] [0] +  + Extension no. + [1] (to lock)/ [0] (to unlock) +
Clearing the PIN and PIN lock for extensions.	[9] [1] +  + Extension no. +
Clearing the PIN and PIN lock for verified codes.	[9] [2] +  + Verified code +
Setting the verified code PIN.	[9] [3] +  + Verified code + PIN (max. 10 digits) +



**WARNING**

When a third party discovers the password (verified code PIN) of the PBX, there will be a risk that they will make fraudulent phone calls using the telephone line, and the cost will be charged to your own account. In order to avoid this problem, we strongly recommend the following points:

- a) Carefully maintain the secrecy of the PIN.
- b) Specify a complicated PIN as long and random as you can make it.
- c) Change the PIN frequently.

## 3.3 System Programming

### 3.3.1 Programming Information

You can customize your system according to your requirements.  
[Your system already has default settings (factory installed).]

**The programming is shown below. (Program number)**

- The date and time [000]
- System speed dialing numbers and names [001]/[002]
- Extension number and name [003]/[004]

#### **Available Extension**

The extension allowed through COS programming

#### **Required Telephone**

A Panasonic Proprietary Telephone with display (over 2 lines)  
(e.g., KX-T7636)

#### **System Password**

To enter programming mode, the system password (max. 10 digits) is required. (Default: 1234)

#### **Conditions**

The programming extension must be idle, on-hook and holding no calls.

#### **List**

Before programming, decide the settings and write them down. Your notes will provide a useful record of the programming for future reference. Your dealer also has programming records which contain all of the system programming. You may ask for photo copies of these tables to be aware of the facilities and features available.

## ◆◆ Icon Descriptions

Fixed Buttons		Function
T7600/NT136	T7200/T7400	
		PREVIOUS (PREV)
		NEXT
		➡
		⬅
		STORE (ENTER)
	None	Back to Previous Menu (CANCEL)
		SHIFT
		PROGRAM
		END
		SELECT
		FLASH
		CLEAR
		SECRET



## ◆◆ Procedure

The basic steps are shown below.

### 1. Entering the programming mode

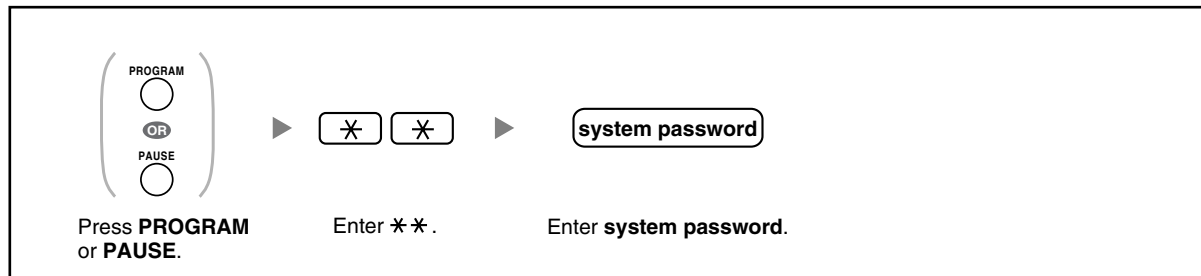

### 2. Programming

You can enter each program number (3 digits).



- To exit the programming mode at any time, lift the handset.

### 3. Exiting the mode

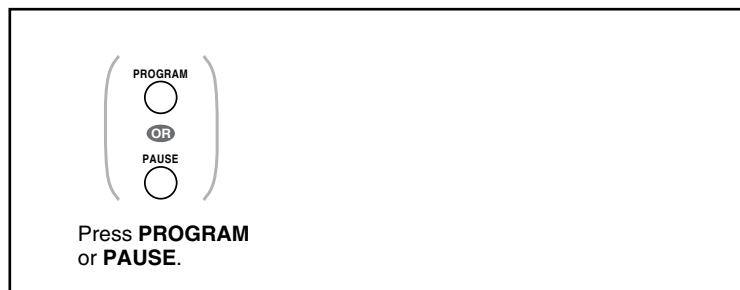

- To exit the programming mode at any time, lift the handset.

## 3.3.2 System Programming

### ◆◆ Date & Time [000]

The proprietary telephones display the current date and time while on-hook.

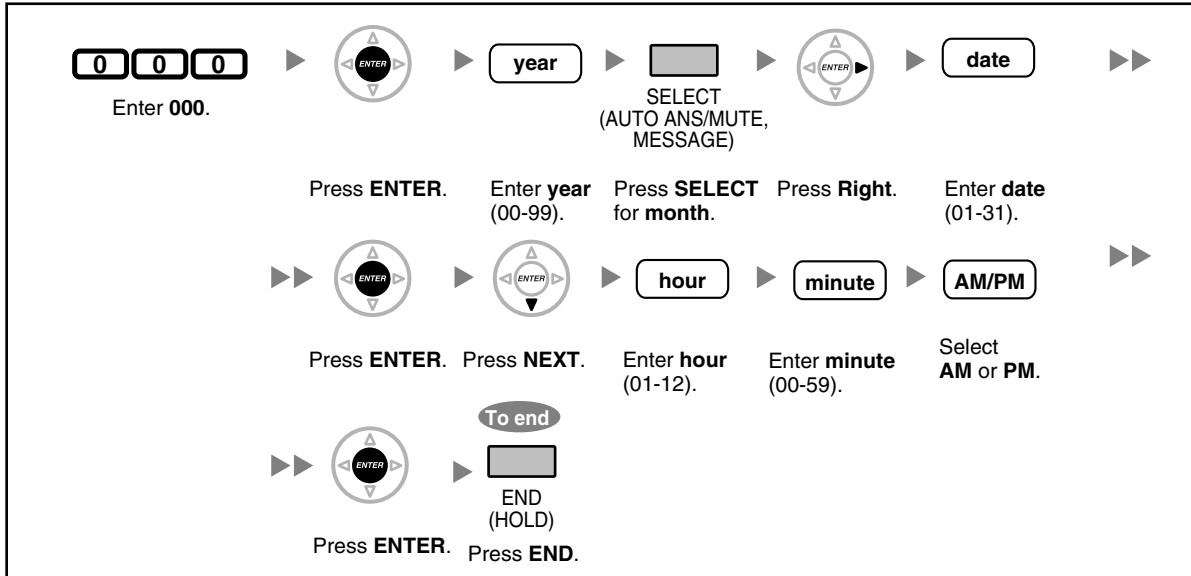

- **After changing the desired values**, you can press the ENTER button. You do not have to perform the rest of the steps.
- The clock starts immediately after the ENTER button is pressed.
- You cannot leave a value empty.
- You can clear the entry by pressing the CLEAR button.
- **To confirm your entry after storing data:**
  - The STORE button light: Lights red.
  - Confirmation Tone:
    - One beep: Your entry is accepted.
    - Three beeps: Your entry is rejected.

## ◆◆ System Speed Dialing Number [001]

You can store the phone numbers of frequently dialed numbers.

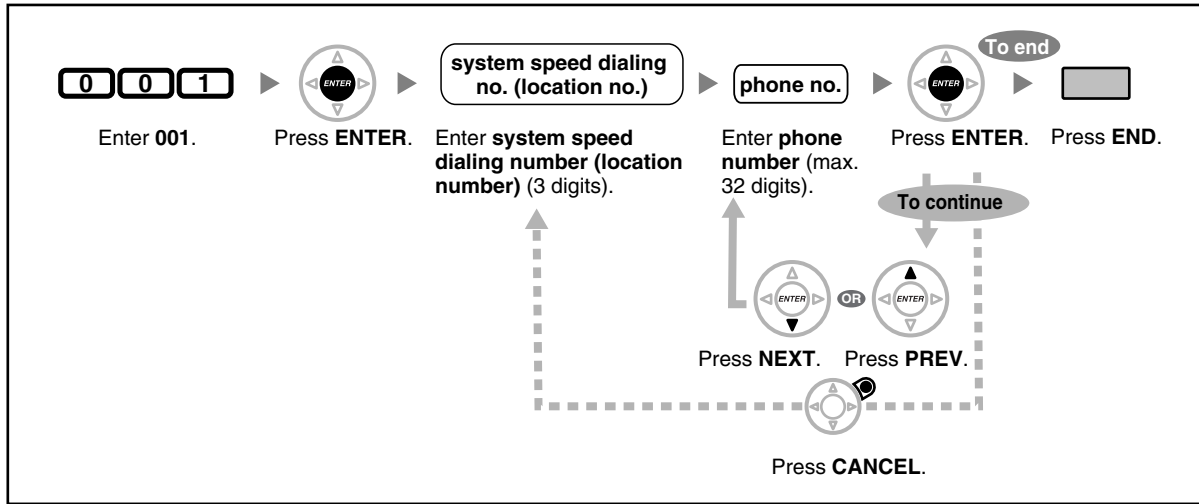

- If the desired number is more than 32 digits, divide the number and store it into a speed dialing number.
- "×", "#", FLASH/RECALL, PAUSE, and SECRET (INTERCOM) can also be stored. If you do not want to display the stored number when making a call, press the SECRET (INTERCOM) button before and after the numbers you wish to conceal. If you store an outside party's number, you should first store a line access number. If you need to enter an account code, you can enter the specified account code before the line access number.

<Example>

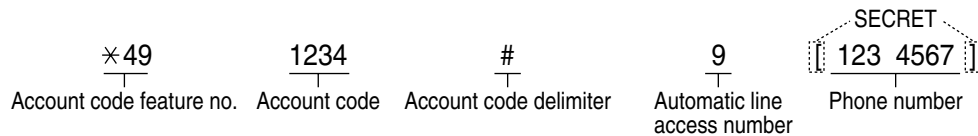

## ◆◆ System Speed Dialing Name [002]

You can store the name associated with the speed dialing number. These names are displayed when making calls using the display operation. To enter characters, refer to "Entering Characters".

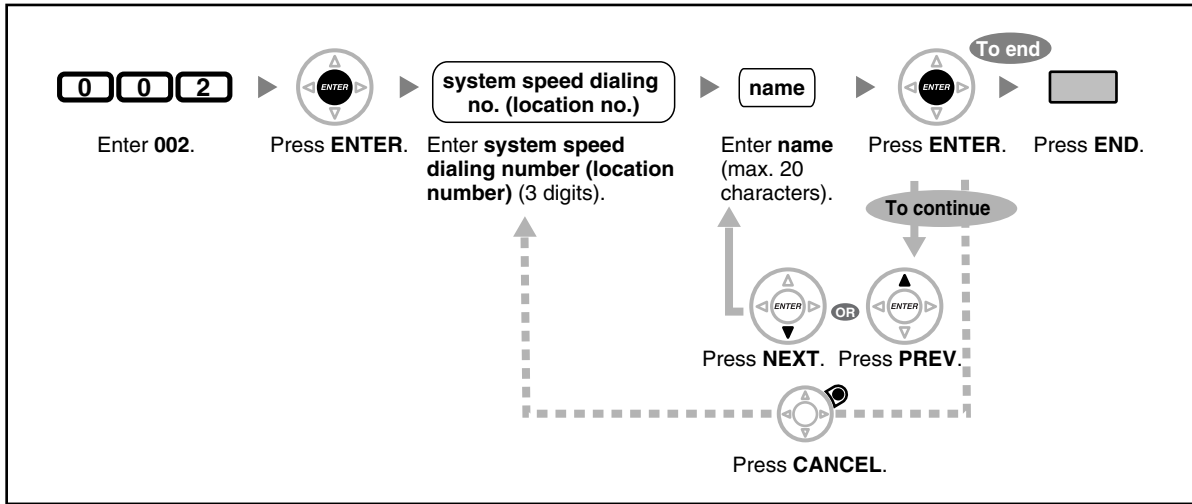

## ◆◆ Extension Number [003]

You can assign an extension number to each extension.

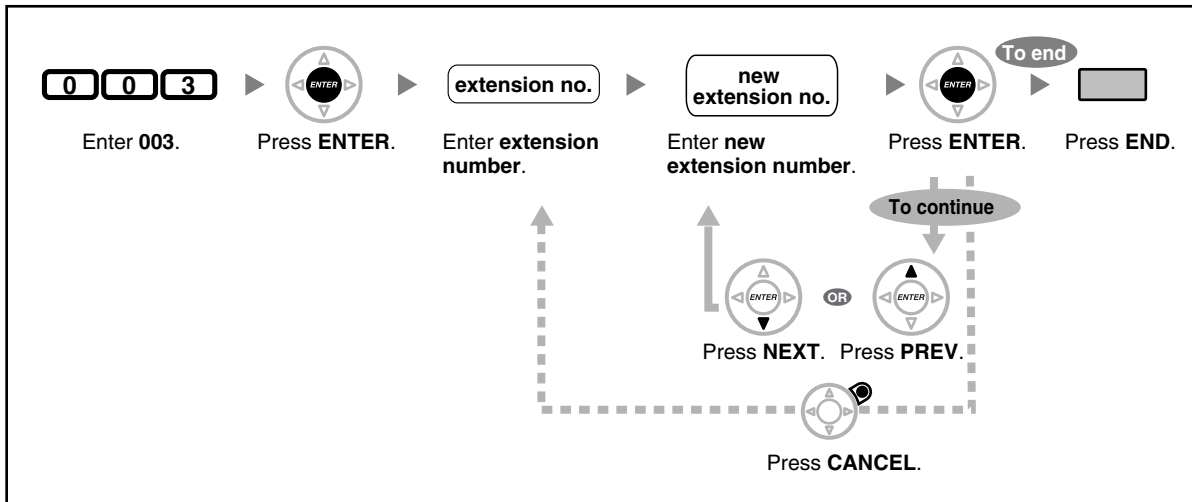

- The leading number(s) should be the same as the number(s) assigned for Flexible Numbering. Consult your dealer.
- A duplicate entry is invalid.

### ◆◆ Extension Name [004]

You can store the name of an extension user. This is useful if you want to know who is calling, or who you are calling when making an intercom call using the directory.  
To enter characters, refer to "Entering Characters".

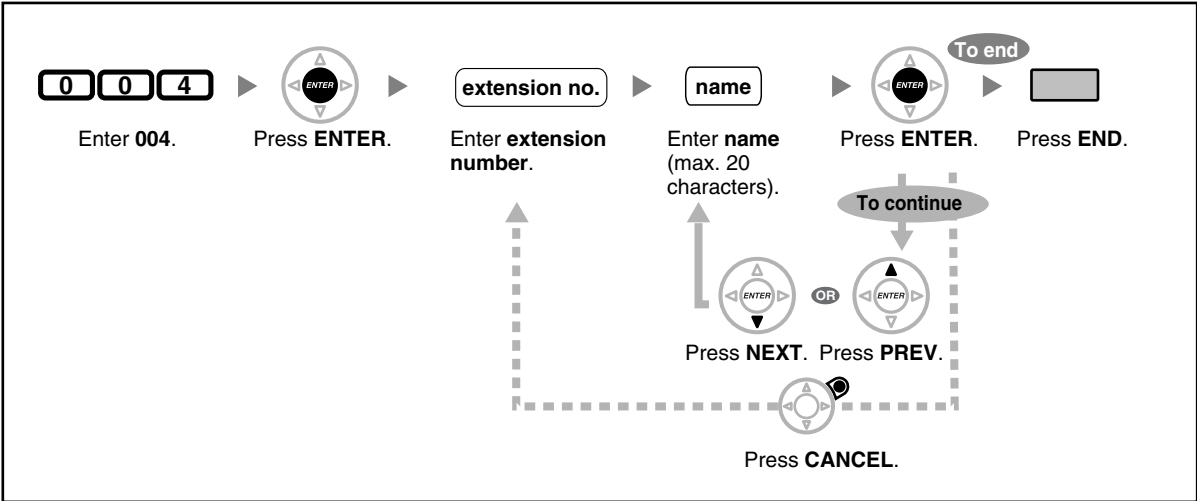



---

# **Section 4**

## **Appendix**

*This chapter provides the Troubleshooting, the Feature Number Table and Tone List. Check the Troubleshooting section before consulting your dealer.*











# 4.1 Troubleshooting







## 4.1.1 Troubleshooting

### ◆◆ Troubleshooting

Problem	Remedy
The telephone does not work properly.	<ul style="list-style-type: none"> <li>➡ Consult your dealer.</li> </ul>
I cannot use the telephone.	<ul style="list-style-type: none"> <li>• <b>The telephone is locked.</b> <ul style="list-style-type: none"> <li>➡ Unlock your telephone. (👉 1.5.3 Extension Lock, 2.1.1 Extension Control)</li> </ul> </li> <li>• <b>Your telephone is connected to an eXtra Device Port.</b> <ul style="list-style-type: none"> <li>➡ System programming is required. Consult your dealer.</li> </ul> </li> </ul>
Some features do not work.	<ul style="list-style-type: none"> <li>• <b>System management may restrict certain features.</b> <ul style="list-style-type: none"> <li>➡ Consult your manager.</li> </ul> </li> <li>• <b>The feature numbers have changed.</b> <ul style="list-style-type: none"> <li>➡ Confirm the revised number and try again.</li> </ul> </li> </ul>
Even though following the manual instructions, none of the operations work when using a proprietary telephone.	<ul style="list-style-type: none"> <li>• <b>The Intercom line was not seized.</b> The seized line, when going off-hook, was changed by personal setting. (👉 3.1.2 Settings on the Programming Mode) <ul style="list-style-type: none"> <li>➡ In the manual, going off-hook means an Intercom line is seized. If the setting has been changed, press the INTERCOM button after going off-hook and follow the instructions.</li> </ul> </li> </ul>
The paralleled single line telephones do not ring.	<ul style="list-style-type: none"> <li>• <b>"No ring" may be selected.</b> Change the setting to ring. (👉 1.7.10 Paralleled Telephone)</li> </ul>
The telephone does not work using the personal settings or with other settings. (One-touch dialing, forwarding destination, etc.)	<ul style="list-style-type: none"> <li>• <b>The extension line has been changed.</b> The previous telephone's settings have not been cleared. <ul style="list-style-type: none"> <li>➡ Clear the settings and then program your desired settings again. (👉 1.7.12 Extension Feature Clear, 3.1.1 Personal Programming, 3.1.3 Customizing the Buttons)</li> </ul> </li> </ul>
My proprietary telephone does not have a feature button.	<ul style="list-style-type: none"> <li>• <b>Some models do not have the feature button.</b> <ul style="list-style-type: none"> <li>➡ Change a flexible button to the desired button. (👉 3.1.3 Customizing the Buttons)</li> <li>➡ Enter the specified feature number instead of the feature button. (👉 1.1.1 Before Operating the Telephones)</li> </ul> </li> </ul>



Problem	Remedy
A reorder tone is audible or "Restricted" is displayed.	<ul style="list-style-type: none"> <li>• <b>The telephone is locked.</b>  <ul style="list-style-type: none"> <li>▶ Unlock your telephone. (  1.5.3 Extension Lock, 2.1.1 Extension Control)</li> </ul> </li> <li>• <b>Toll restriction is activated.</b>  <ul style="list-style-type: none"> <li>▶ Consult your manager or dealer.</li> </ul> </li> <li>• <b>An account code is required.</b> (  1.2.6 Calling without Restrictions, Account Code Entry in 1.2.1 Basic Calling)</li> </ul>
I cannot make an outside call using the One-touch Dialing button or speed dialing.	<ul style="list-style-type: none"> <li>• <b>A line access number was not stored.</b>  <ul style="list-style-type: none"> <li>▶ A line access number is required for outside calls. (  1.2.1 Basic Calling, 3.1.3 Customizing the Buttons)</li> </ul> </li> </ul>
I cannot remember the feature numbers.	<ul style="list-style-type: none"> <li>• ▶ Ask your dealer to change the feature numbers for easier use.</li> </ul>
While talking to an outside party, the line is disconnected.	<ul style="list-style-type: none"> <li>• <b>The time limit has run out.</b> (  1.4.1 Call Transfer, 1.4.5 Multiple Party Conversation)  <ul style="list-style-type: none"> <li>▶ Consult your dealer to extend the time, if necessary.</li> </ul> </li> </ul>
Redialing does not function.	<ul style="list-style-type: none"> <li>• <b>The stored number was more than 32 digits or an extension number.</b> (  1.2.3 Redial)</li> </ul>
The personal computer and fax machine communication failed.	<ul style="list-style-type: none"> <li>• <b>An indication tone may have interrupted communication.</b> (  1.7.8 Data Line Security)</li> </ul>
I do not want to show my telephone number to the calling or called party's telephone.	<ul style="list-style-type: none"> <li>• ▶ Consult your manager or dealer.</li> </ul>
I want to show my telephone number to the calling or called party's telephone.	<ul style="list-style-type: none"> <li>• (  1.7.4 Calling Line Identification Presentation (CLIP))</li> </ul>
I cannot send a call waiting tone to the dialed extension.	<ul style="list-style-type: none"> <li>• <b>The other party has not set the Call Waiting feature.</b>  (  Call Waiting, 1.4.4 Call Waiting, 1.7.3 Call Waiting/Off-hook Call Announcement (OHCA)/Whisper OHCA)</li> <li>• <b>The other party has set Data Line Security.</b>  (  1.7.8 Data Line Security)</li> </ul>
I forgot the password.	<ul style="list-style-type: none"> <li>• Ask the manager to assist you.  (  2.1.1 Extension Control)</li> </ul>
The background music started suddenly.	<ul style="list-style-type: none"> <li>• ▶ Turn off the music.  (  1.7.7 Background Music (BGM), 2.1.4 External Background Music (BGM))</li> </ul>

Problem	Remedy
<p><b>I do not want to display a number which is stored in memory.</b></p>	<ul style="list-style-type: none"> <li>  Conceal the number.                      (  Storing Names and Numbers, 3.1.3 Customizing the Buttons)                 </li> </ul>
<p><b>I want to confirm my extension number.</b></p>	<ul style="list-style-type: none"> <li>                     (  Your Extension Number in 1.1.1 Before Operating the Telephones)                 </li> </ul>
<p><b>The date and time are not correct.</b></p>	<ul style="list-style-type: none"> <li> <p><b>Set the date and time by system programming.</b></p>                     (  Date &amp; Time [000] in 3.3.2 System Programming)                 </li> </ul>
<p><b>The display is not shown well.</b></p>	<ul style="list-style-type: none"> <li>  Change the Display contrast level.                      (  3.1.2 Settings on the Programming Mode)                 </li> </ul>
<p><b>I want to distinguish the tones.</b></p>	<ul style="list-style-type: none"> <li>                     (  To distinguish the ringing tones for each CO, INTERCOM or G-DN button (Digital proprietary telephone only), 3.1.3 Customizing the Buttons)                 </li> </ul>
<p><b>The MESSAGE button light lit.</b></p>	<ul style="list-style-type: none"> <li> <p><b>Another extension left you a message waiting indication while you were on the phone or away from your desk.</b></p> </li> </ul>

## 4.2 Feature Number Table

### 4.2.1 Feature Number Table

Numbers listed below are the default settings. There are flexible feature numbers and fixed feature numbers. If you change the flexible feature numbers, fill in your assigned numbers (new) in the list for future reference.

Feature (While dial tone is heard)	Default (New)	Additional digits
1.2.1 Basic Calling		
Operator Call	0 (     )	
Automatic Line Access	9 (     )	outside phone no.
CO Line Group Access	8 (     )	CO line group no. (2 digits) + outside phone no.
TIE Line Access	7 (     )	private phone no.
Account Code Entry	*49 (     )	account code + # + outside phone no.
1.2.2 Easy Dialing		
Personal Speed Dialing		
– To store	*30 (     )	personal speed dialing no. (2 digits) + outside phone no. + #
– To dial	** (     )	* + personal speed dialing no. (2 digits)
System Speed Dialing		
– To dial	** (     )	system speed dialing no. (3 digits)
Hot Line	*740 (     )	
– To store		2 + phone no. + #
– To set		1
– To cancel		0
1.2.3 Redial		
Last Number Redial	# (     )	

## 4.2 Feature Number Table

Feature (While dial tone is heard)	Default (New)	Additional digits
<p>1.2.4 When the Dialed Line is Busy or There is No Answer</p> <p>Automatic Callback Busy Cancel</p> <p style="padding-left: 20px;">×46 (        )</p> <p>Message Waiting</p> <p>For a caller</p> <p style="padding-left: 20px;">– To leave/cancel</p> <p>For a called extension</p> <p style="padding-left: 20px;">– To call back – To clear</p>		<p>1/0 + extension no.</p> <p>2 0 + your extension no.</p>
<p>1.2.6 Calling without Restrictions</p> <p>Remote COS Access</p> <p>To call (Verified Code Entry)</p>	<p style="padding-left: 20px;">×47 (        )</p>	<p>extension no. + extension PIN + phone no.</p> <p>× + verified code + verified code PIN + phone no.</p>
<p>1.2.7 Direct Inward System Access (DISA)</p> <p>Calling through DISA</p> <p style="padding-left: 20px;">– To an extension (In All Security Mode only)</p> <p style="padding-left: 20px;">– To an outside party (In Trunk Security Mode/All Security Mode only)</p>		<p>your extension no./(× + verified code) + extension PIN/verified code PIN + extension no.</p> <p>your extension no./(× + verified code) + extension PIN/verified code PIN + outside phone no.</p>
<p>1.2.8 Remote Setting</p> <p style="padding-left: 20px;">– From another extension – Through DISA</p>		<p>your extension no. + extension PIN + feature no.</p>
<p>1.3.3 Call Pickup</p> <p>Call Pickup</p> <p style="padding-left: 20px;">– Group</p> <p style="padding-left: 20px;">– Directed</p> <p>Call Pickup Deny</p> <p style="padding-left: 20px;">– To deny – To allow</p>	<p style="padding-left: 20px;">×40 (        )</p> <p style="padding-left: 20px;">×41 (        )</p> <p style="padding-left: 20px;">×720 (        )</p>	<p>group no. (2 digits)</p> <p>extension no.</p> <p>1 0</p>

Feature (While dial tone is heard)	Default (New)	Additional digits
1.3.4 Trunk Answer From Any Station (TAFAS) – Calls through an external speaker	*42 (        )	speaker no. (1 digit)
1.4.2 Call Hold Call Hold/Call Hold Retrieve  Call Hold Retrieve – Specified with a held line number  – Specified with a holding extension number  Call Park – To set – To retrieve	*50 (        )  *53 (        )  *51 (        )  *52 (        )	CO line no. which is held (3 digits)  extension no. which has a held call  parking zone no. (2 digits)/* stored parking zone no. (2 digits)
1.4.4 Call Waiting Answering Call Waiting in the PBX  Answering Call Waiting from the Telephone Company	*50 (        )  *60 (        )	
1.5.1 Call Forwarding Call Forwarding (FWD)/ 1.7.2 Do Not Disturb (DND) – Both Calls  – Outside Calls  – Intercom Calls	*710 (        )  *711 (        )  *712 (        )	0 (Cancel)/ 1 (Do Not Disturb [DND])/ 2 (All calls) + phone no. + #/ 3 (Busy) + phone no. + #/ 4 (No Answer) + phone no. + #/ 5 (Busy/No Answer) + phone no. + #/ 7 (Follow Me) + your extension no./ 8 (Follow Me Cancel) + your extension no.

## 4.2 Feature Number Table

Feature (While dial tone is heard)	Default (New)	Additional digits
–To set the timer for "No Answer" and "Busy/No Answer" Call Forwarding (FWD) for your Incoming Call Distribution Group – Both Calls – Outside Calls – Intercom Calls	*713 (        )  *714 (        )  *715 (        )  *716 (        )	00-99 (second)  1 (Set) + ICD Group extension no. + phone no. + #/0 (Cancel) + ICD Group extension no.
1.5.2 Absent Message – To set – To cancel	*750 (        )	1-9 (+ parameter) + # 0
1.5.3 Extension Lock – To lock – To unlock	*77 (        )	1 0 + extension PIN
1.6.1 Paging Group Paging	*33 (        )	paging group no. (2 digits)
1.6.2 Answering/Denying a Paging Announcement – To answer – To deny – To allow	*43 (        )  *721 (        )	1 0
1.7.1 Timed Reminder – To set – To cancel	*760 (        )	12H: 1 + time (hour/minute) + 0 (AM)/1 (PM) + 0 (once)/1 (daily) 24H: 1 + time (hour/minute) + 0 (once)/1 (daily) 0
1.7.3 Call Waiting/Off-hook Call Announcement (OHCA)/Whisper OHCA – For intercom calls (No call/Tone/OHCA/Whisper OHCA) – For outside calls (No tone/Tone)	*731 (        )  *732 (        )	0 (No call)/1 (Tone)/2 (OHCA)/3 (Whisper OHCA) 0 (No tone)/1 (Tone)

Feature (While dial tone is heard)	Default (New)	Additional digits
1.7.4 Calling Line Identification Presentation (CLIP) – Public – Your extension	*7*2 (        )	1 2
1.7.5 Calling Line Identification Restriction (CLIR) – To show – To prevent	*7*1 (        )	0 1
1.7.6 Executive Busy Override Deny – To prevent – To allow	*733 (        )	1 0
1.7.7 Background Music (BGM) – To select – To cancel	*751 (        )	BGM no. (1 digit) 0
1.7.8 Data Line Security – To set – To cancel	*730 (        )	1 0
1.7.10 Paralleled Telephone – Ring – No Ring	*39 (        )	1 0
1.7.11 Wireless XDP Parallel Mode – To set – To cancel	*48 (        )	1 + paired wired extension no. 0
1.7.12 Extension Feature Clear	*790 (        )	
1.8.1 Log-in/Log-out, Wrap-up Log-in Log-out To enter/leave the Not Ready mode	*736 (        )  *735 (        )	1 + ICD Group extension no./* 0 + ICD Group extension no./* 1 (Not Ready)/0 (Ready)
*3 1.8.2 Incoming Call Distribution Group Monitor	*739 (        )	ICD Group extension no.

## 4.2 Feature Number Table

Feature (While dial tone is heard)	Default (New)	Additional digits
1.9.1 Doorphone/Door Opener Doorphone Call  Door Open	✕31 (       )  ✕55 (       )	doorphone no. (2 digits)  doorphone no. (2 digits)
1.9.2 External Relay	✕56 (       )	relay no. (2 digits)
1.9.4 Host PBX External Feature Access (EFA)	✕60 (       )	service code
1.9.5 Voice Processing System Call Forwarding to Voice Mail (Voice Mail Integration) – Both Calls  – Outside Calls  – Intercom Calls	✕710 (       )  ✕711 (       )  ✕712 (       )	0 (Cancel)/  2 (All Calls)/  3 (Busy)/ 4 (No Answer)/ 5 (Busy/No Answer) + voice mail floating extension no. + #
1.10.1 Walking Extension	✕727 (       )	your previous extension no. + extension PIN
2.1.1 Extension Control *1 Remote Extension Lock – To unlock  – To lock	✕782 (       )  ✕783 (       )	extension no.  extension no.
*2 2.1.2 Time Service Mode Control – Day/Night/Lunch/Break	✕780 (       )	0/1/2/3
*1 2.1.4 External Background Music (BGM) – To play  – To stop	✕35 (       )	external pager no. (1 digit)/✕ + BGM no. (1 digit)  external pager no. (1 digit)/✕ + 0



Feature (While dial tone is heard)	Default (New)	Additional digits
*1 2.1.5 Outgoing Messages (OGM) <ul style="list-style-type: none"> <li>– To record</li> <li>– To play back</li> <li>– To record from an external BGM (MOH) port</li> <li>– To clear</li> </ul>	*36 (        )	1 + OGM floating extension no. 2 + OGM floating extension no. 3 + BGM port no. (1 digit) + OGM floating extension no. 0 + OGM floating extension no.
2.1.6 Hospitality Features <ul style="list-style-type: none"> <li>*4 Setting a Timed Reminder to a Room Extension (Remote Wake-up Call)               <ul style="list-style-type: none"> <li>– To set</li> <li>– To cancel</li> <li>– To confirm</li> </ul> </li> <li>Recording room information using a room extension</li> </ul>	*76* (        )	12H: 1 + extension no. + hour/minute + 0 (AM)/ 1 (PM) + 0 (once)/1 (daily) 24H: 1 + extension no. + hour/minute + 0 (once)/1 (daily) 0 + extension no. 2 + extension no. message no. (+ parameter) + #
*1 2.1.7 Network Direct Station Selection (NDSS) Monitor Release	*784 (        )	another PBX extension no. + #
3.1.1 Personal Programming <ul style="list-style-type: none"> <li>Extension PIN (Personal Identification Number)               <ul style="list-style-type: none"> <li>– To set</li> <li>– To cancel</li> </ul> </li> </ul>	*799 (        )	1 + extension PIN + # + same extension PIN + # 0 + stored extension PIN

\*1 : Manager only

\*2 : Manager and preprogrammed extension user only

\*3 : Supervisor only

\*4 : Hotel operator only

## 4.2 Feature Number Table

---

<b>Feature (While busy, DND or call tone is heard)</b>	<b>Default</b>
1.2.4 When the Dialed Line is Busy or There is No Answer	
Call Waiting	1
DND Override	
Executive Busy Override	3
Message Waiting	4
Call Monitor	5
Automatic Callback Busy	6
1.2.5 Alternate Calling—Ring/Voice	*

<b>Feature (While dialing or talking)</b>	<b>Fixed Number</b>
1.4.5 Multiple Party Conversation	
Conference	3
1.9.1 Doorphone/Door Opener	
From any extension while talking to the doorphone	5

# 4.3 Tone

## 4.3.1 Tone

### While on-hook

#### Ring Tones

The following tones are programmable allowing recognition of call type (Outside, Intercom or Doorphone).

#### Tone 1

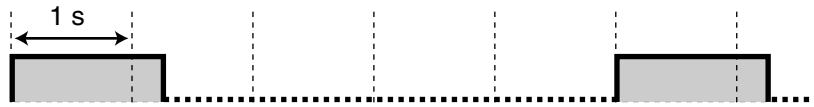

#### Tone 2



#### Tone 3

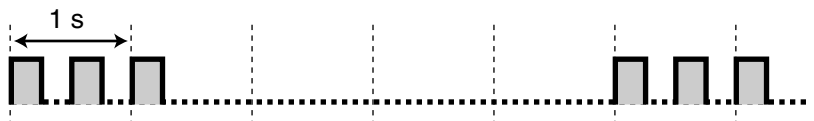

#### Tone 4

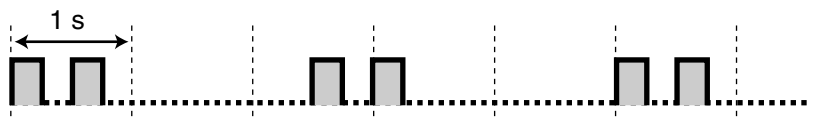

### When going off-hook

#### Dial Tones

#### Tone 1

Normal

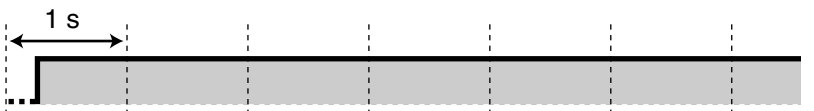

**Tone 2**

Any one of the following features is set:

- Absent Message
- Background Music
- Call Forwarding
- Call Pickup Deny
- Call Waiting
- Do Not Disturb
- Extension Lock
- Executive Busy Override Deny
- Hot Line
- Timed Reminder

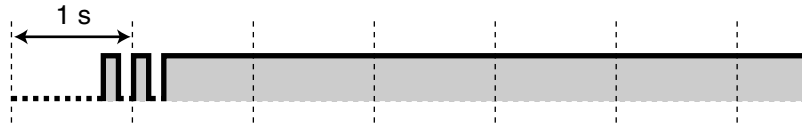

**Tone 3**

- After pressing TRANSFER or Recall/hookswitch to hold a call temporarily (e.g., Call Splitting)
- While a called PS is being searched
- When Account Code Entry is performed
- When answering a Timed Reminder call with no message
- When answering an external sensor call



**Tone 4**

Message waiting indication was received.

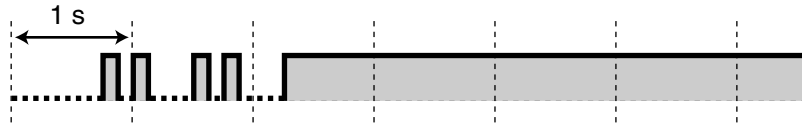

**When you make calls**

**Busy Tone**

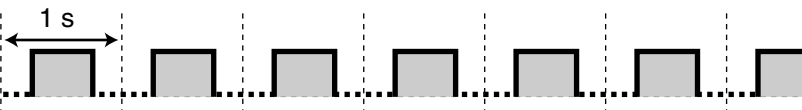

**Reorder Tone**

The CO line you tried to seize is not assigned or denied.

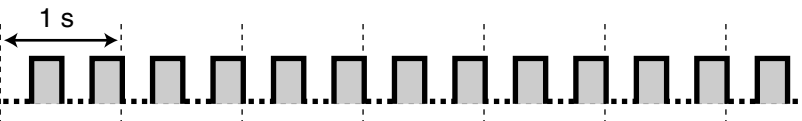

**Ringback Tone 1**

Normal ringback tone



**Ringback Tone 2**

Special ringback tone for DISA call



**Do Not Disturb (DND) Tone**

The dialed extension is refusing incoming calls.



**While off-hook**

**Indication Tones**

**Tone 1**

Call waiting tone

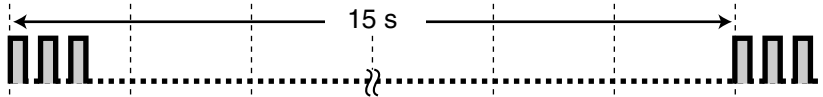

**Tone 2**

A call is on hold longer than the specified time.

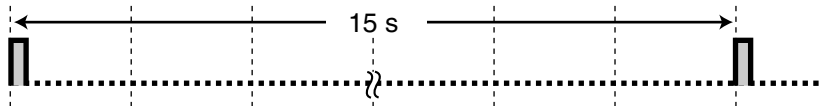

**When talking to an outside party**

**Warning Tone**

This tone is sent 15, 10 and 5 seconds before the specified time for disconnection.



**When setting the features or programming**

**Confirmation Tones**

**Tone 1**

The feature setting was set successfully.



**Tone 2**

Before receiving a page through an external speaker

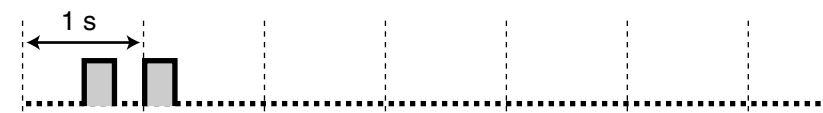

**Tone 3**

Before the following features activate:

- Retrieving a held call
- Picking up another call
- Paging/Answering a paging announcement
- Answering the call through a speaker



## 4.3 Tone

---

### Tone 4

Establishing or leaving a conference

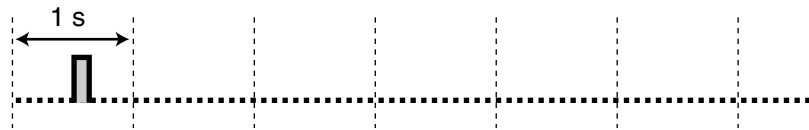

### Tone 5

A call has been put on hold.

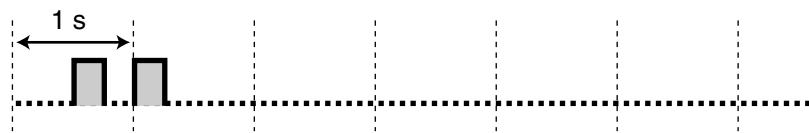

## 4.4 Revision History

### 4.4.1 Version 1.1

#### Changed Contents

- 1.1.1 Before Operating the Telephones
  - When You Use a Panasonic Proprietary Telephone
    - FLASH/RECALL
- 1.2.4 When the Dialed Line is Busy or There is No Answer
  - Message Waiting
    - To clear message waiting indications left on your extension
- 1.11.1 Call Log
  - Incoming Call Log
  - Outgoing Call Log
- 1.11.2 Directories
  - Calling with the Directory
  - Storing Names and Numbers
  - Entering Characters

### 4.4.2 Version 2.0

#### New Contents

- 1.1.1 Before Operating the Telephones
  - When You Use a Panasonic Proprietary Telephone
    - Network Direct Station Selection (NDSS)
    - CTI
    - Check-in
    - Check-out
- 1.2.1 Basic Calling
  - TIE Line Access
    - To call with one touch
- 1.9.2 External Relay
- 1.9.3 External Sensor
- 2.1.6 Hospitality Features
- 2.1.7 Network Direct Station Selection (NDSS) Monitor Release

#### Changed Contents

- 1.2.2 Easy Dialing
  - Personal Speed Dialing
    - To store a phone number





---

# ***Index***

- A**
- Absence Settings 70
  - Absent Message 73, 131, 158
  - Account 19, 138
  - Account Code Entry 27, 155
  - Alternate Calling—Ring/Voice 38, 162
  - Alternate Receiving—Ring/Voice 130
  - Answer 18, 19, 47, 138
  - ANSWER/RELEASE Button 47
  - Answering Call Waiting from the Telephone Company 59
  - Answering Call Waiting in the PBX 56
  - Answering Calls 44
  - Answering/Denying a Paging Announcement 77
  - Appendix 151
  - AUTO ANS (Auto Answer)/MUTE 17
  - AUTO DIAL/STORE 17
  - Automatic Call Hold 53
  - Automatic Callback Busy 31, 162
  - Automatic Callback Busy Cancel 32, 156
  - Automatic Line Access 24, 155
- B**
- Background Music (BGM) 83, 132, 159
  - Basic Calling 23
  - Before Operating the Telephones 14
  - Boss & Secretary feature 70
  - Busy Station Signaling (BSS) → Call Waiting 33
  - Busy Tone 164
- C**
- Call Center 87
  - Call Forwarding 70
  - Call Forwarding (FWD) 17, 70
  - Call Forwarding (FWD)/Do Not Disturb (DND)—Both calls 19, 137
  - Call Forwarding [FWD] for your Incoming Call Distribution Group 72
  - Call Forwarding to Voice Mail (Voice Mail Integration) 96
  - Call Hold 51, 157
  - Call Hold Retrieve 52, 157
  - Call Log 19, 138
  - Call Log for ICD Group 19, 138
  - Call Monitor 37, 162
  - Call Park 19, 53, 138, 157
  - Call Park (Automatic Park Zone) 19, 53, 138, 157
  - Call Park Retrieve 54
  - Call Pickup 45
  - Call Pickup Deny 46, 156
  - Call Splitting 55
  - Call Transfer 49
  - Call Waiting 33, 56, 81, 158, 162
  - Call Waiting from the Telephone Company 157
  - Call Waiting in the PBX 157
  - Call Waiting Selection 131
  - Call Waiting Tone Type Selection 131
  - Call Waiting/Off-hook Call Announcement (OHCA)/Whisper OHCA 81
  - Calling an Outside Party 24
  - Calling Another Extension 23
  - Calling Line Identification Presentation (CLIP) 82, 129, 159
  - Calling Line Identification Restriction (CLIR) 20, 82, 129, 139, 159
  - Calling through DISA 40
  - Calling without Restrictions 39
  - CANCEL 18
  - Changing the Settings and Extension Control 142
  - Changing the Settings of Other Extensions 114
  - Check-in 20, 119, 139
  - Check-out 20, 120, 139
  - Clearing Features 135
  - CO 17
  - CO Line Group Access 25, 155
  - Conference 17, 19, 60, 138
  - Confirmation Tones 165
  - Connected Line Identification Restriction (COLR) 20, 139
  - Connection Example 22
  - Control Features 114
  - CTI 20, 139
  - Customized Buttons 18
  - Customizing the Buttons 137
  - Customizing Your Phone & System 125
- D**
- Data Line Security 84, 159
  - Date & Time [000] 146
  - Dial Tone Transfer 116
  - Dial Tones 163
  - Direct Inward System Access (DISA) 40
  - Direct Station Selection (DSS) 19, 137
  - Directories 107
  - Directory and Call Log Lock 133
  - Display 15
  - Display Backlight Selection 129
  - Display Language Selection 128
  - Display Proprietary Telephone 103
  - Display Switching Mode 129
  - DND Override 37, 162
  - Do Not Disturb (DND) 17, 79
  - Do Not Disturb (DND) Tone 165
  - Door Open 94, 160
  - Doorphone Call 93, 160
  - Doorphone/Door Opener 93
  - During a Conversation 49
- E**
- Easy Dialing 27
  - Electronic Station Lockout → Extension Lock 75, 133, 158
  - ENTER 18
  - Entering Characters 109
  - Examples 15
  - Exclusive Call Hold 51
  - Executive Busy Override 35, 162
  - Executive Busy Override Deny 83, 132, 159
  - Extension Control 114
  - Extension Feature Clear 86, 159
  - Extension Lock 75, 133, 158
  - Extension Name [004] 149
  - Extension Number [003] 148
  - Extension PIN (Personal Identification Number) 126, 133, 161
  - Extension Settings 78
  - External Background Music (BGM) 116, 160
  - External Feature Access (EFA) 19, 95, 138, 160

External Relay 94  
External Sensor 95

## F

Feature Highlights 2  
Feature Number Table 155  
Feature Numbers 14  
Fixed Buttons 17  
FLASH/RECALL 17  
Forced Answerback Selection 130  
FWD N/A Timer 132  
FWD/DND Cycle Switch Mode 73, 80  
FWD/DND Setting Mode 73, 80  
FWD/DND—Intercom calls 19, 137  
FWD/DND—Outside calls 19, 137

## G

Group Directory Number (G-DN) 19, 137  
Group FWD—Both calls 19, 138  
Group FWD—Intercom calls 19, 138  
Group FWD—Outside calls 19, 138  
Group Paging 76, 158  
Group-CO (G-CO) 18, 137

## H

Handset/Headset Selection → Headset Operation 68, 132  
Hands-free Answerback 45  
Hands-free operation 68  
Headset 20, 68, 139  
Headset Operation 68, 132  
HOLD 17  
Hospitality Features 118  
Host PBX 95  
Hot Line 29, 155  
How to Follow the Steps 21  
Hurry-up 19, 138  
Hurry-up Transfer → Manual Queue Redirection 92

## I

Icon Descriptions 16, 144  
Incoming Call Distribution Group Monitor 89, 90, 159  
Incoming Call Log 103  
Indication Tones 165  
INTERCOM 17  
Intercom Call 23

## J

Jog Dial 18

## K

Key Pad Tone Set 132

## L

Last Number Redial 31, 155  
LCS Mode Set (After Answering) 131  
Leaving Three-party Conference 65  
Live Call Screening (LCS) 20, 97, 139

Live Call Screening Mode Set 131  
Log-in/Log-out 19, 87, 138, 159  
Log-in/Log-out for all groups 19, 138  
Log-in/Log-out of a specified group 19, 138  
Log-in/Log-out, Wrap-up 87  
Loop-CO (L-CO) 18, 137

## M

Making Calls 23  
Manager Operation 113  
Manager Password 141  
Manager Programming 141, 142  
Manual Queue Redirection 92  
Message 17, 19, 137  
Message for another extension 19, 137  
Message Waiting 33, 156, 162  
MODE 18  
MONITOR 17  
Monitoring and Changing the Log-in/Log-out Status of Extensions 91  
Monitoring the Status of Waiting Calls 90  
Multiple Party Conversation 60  
Mute 67

## N

Navigator Key 18  
Network Direct Station Selection (NDSS) 20, 139  
Network Direct Station Selection (NDSS) Monitor Release 123

## O

Off-Hook Call Announcement (OHCA) 81  
Off-Hook Monitor 67  
Off-hook Monitor 67  
One-touch Dialing 19, 28, 137  
One-touch Dialing Assignment Mode Selection 133  
One-touch Transfer 50  
One-touch Two-way Transfer 20, 100, 139  
Operation 13  
Operator Call 24, 155  
Outgoing Call Log 106  
Outgoing Messages (OGM) 117, 161

## P

Paging 76  
Paging and then Transferring a Call 76  
Paging Deny 77, 132  
Paralleled Telephone 85, 130, 159  
PAUSE 17  
Personal Absent Message 131  
Personal Programming 126  
Personal Speed Dialing 28, 155  
Pickup Dialing → Hot Line 29, 155  
Portable Station (PS) Registration 14  
Predialing 25  
Preferred Line Assignment—Incoming 130  
Preferred Line Assignment—Outgoing 130  
Privacy Release 66  
PROGRAM 18  
Programmable Feature (PF) 18

Programming Information 141, 143

**Q**

Quick Dialing 30

**R**

Receiving Calls 44  
Recording room information using a room extension 122  
Redial 17, 31  
Release 18, 20, 47, 138  
Remote COS Access 39, 156  
Remote Extension Lock 114, 160  
Remote Setting 42, 156  
Remote Station Lock Control → Remote Extension Lock 114, 160  
Reorder Tone 164  
Required Telephone 141, 143  
Restrictions 15  
Revision History 167  
Ring Tones 163

**S**

SELECT 18  
Setting a Timed Reminder to a Room Extension (Remote Wake-up Call) 121  
Setting Features 128  
Settings on the Programming Mode 127  
SHIFT 18  
Single-CO (S-CO) 19, 137  
Soft Buttons 17  
SP-PHONE 17  
Station Program Clear → Extension Feature Clear 86, 159  
Station Speed Dialing → Personal Speed Dialing 28, 155  
Storing Names and Numbers 108  
System Alarm 19, 138  
System Feature Access 111  
System Password 143  
System Programming 143, 146  
System Speed Dialing 29, 155  
System Speed Dialing Name [002] 148  
System Speed Dialing Number [001] 147

**T**

Terminate 19, 138  
TIE Line Access 26, 155  
Time Service 84  
Time Service (Day/Night/Lunch/Break) 19, 84, 114, 138, 160  
Time Service Mode Control 114  
Time Service Switching Mode (Automatic/Manual) 20, 115, 139  
Timed Reminder 78, 158  
To answer a sensor call 95  
To cancel 121  
To check in 119  
To check out 120  
To confirm 121  
To record 122  
To set 121  
To store the caller's information in personal speed dialing 106  
To switch on the relay 94

Toll Restriction 20, 139  
Tone 15, 163  
Tone 1 165  
Tone 2 165  
TRANSFER 17  
Transferring to an Extension on the PBX 49  
Transferring to an Outside Party Using the PBX Service 50  
Troubleshooting 152  
Trunk Answer From Any Station (TAFAS) 46, 157  
Two-way Record 20, 100, 139  
Two-way Transfer 20, 100, 139

**U**

Unattended Conference 64  
User-supplied Equipment 93  
Using a Navigator Key/Jog Dial/Volume Key 15

**V**

Verified Code Entry 39, 156  
Version 1.1 167  
Version 2.0 167  
VOICE CALL/MUTE 17  
Voice Mail Integration 96, 160  
Voice Mail Transfer 20, 96, 139  
Voice Processing System 96  
Volume Key 18

**W**

Walking COS 39  
Walking Extension 102, 160  
Walking Station → Walking Extension 102, 160  
Warning Tone 165  
What Kind of Telephone Can Be Used? 14  
When the Dialed Line is Busy or There is No Answer 31  
When You Use a Panasonic Proprietary Telephone 17  
Whisper OHCA 81  
Wireless XDP Parallel Mode 85, 159  
Wrap-up 19, 87, 138

**Y**

Your Extension Number 15



**Panasonic Consumer Electronics Company  
Division of Panasonic Corporation of North America**

One Panasonic Way  
Secaucus, NJ 07094

**Panasonic Puerto Rico, Inc.**

Ave. 65 de Infantería, Km. 9.5  
San Gabriel Industrial Park  
Carolina, Puerto Rico 00985

**<http://www.panasonic.com/csd>**

**Copyright:**

This material is copyrighted by Panasonic Communications Co., Ltd., and may be reproduced for internal use only. All other reproduction, in whole or in part, is prohibited without the written consent of Panasonic Communications Co., Ltd.

© 2003 Panasonic Communications Co., Ltd. All Rights Reserved.

**PSQX2231XA** KK0703EK2015